

PUBLIC



Specification – Distribution Transformers

Standard Number: HPC-8DJ-07-0001-2013

Original Issue Date: 28th May 2013

Document Number: 1759206

Print Date: 28/07/2023

Uncontrolled document when downloaded. Refer to Horizon Power's website for most current version.

© Horizon Power Corporation 2016

Document Control		
Author	Name: Paul Savig Position: Senior Standards & Plant Engineer	
Review by	Name: Kai Chong Jee Position: Senior Standards & Plant Engineer	
Endorsed By	Name: Johnathan Choi Position: Standards and Plant Manager	
Approved By *	Name: Victor Cheng Position: Senior Manager Engineering and Project Services	
Date Created/Last Updated	28 July 2023	
Review Frequency **	3 years	
Next Review Date **	28 July 2026	

* This person will have the power to grant the process owner the authority and responsibility to manage the process from end to end.

** Frequency period is dependent upon circumstances– maximum is 5 years from last issue, review, or revision whichever is the latest. If left blank, the default must be 1 year unless otherwise specified.

Revision Control		
Revision	Date	Description
2	28/07/2023	Updating of Standards, References and LV Switchgear
1	20/01/2017	First Revision
0	28/05/2013	Initial Document Creation

STAKEHOLDERS	
<i>The following positions must be consulted if an update or review is required:</i>	
Manager Engineering & Project Services	Asset Managers
Manager Systems & Network Planning	Manager Assets Services
Senior Manager Safety, Health and Wellbeing	

TABLE OF CONTENTS

1	SCOPE	7
2	NORMATIVE REFERENCES	7
2.1	Standards	7
2.1.1	Horizon Power Standards	7
2.1.2	Australian Standards	7
2.1.3	International Standards	9
2.1.4	Compliance with Standards	9
2.2	Definitions and Abbreviations	10
2.3	Drawings	10
3	REQUIREMENTS	11
3.1	Power System Particulars	11
3.1.1	Rated Voltages	11
3.1.2	Fault Rating	11
3.1.3	Nominal System Frequency	11
3.1.4	System Insulation Levels	11
3.1.5	Pollution Performance	12
3.2	Service Conditions	12
3.2.1	Environmental Conditions	12
3.2.2	Operational Conditions	12
3.2.2.1	Cyclic Loading	12
3.2.2.2	Cooling Criteria	12
3.2.2.3	Seismic Disturbances	13
3.2.2.4	Wind Loads	13
3.2.2.5	Noise	13
3.2.3	Service Conditions	13
4	TRANSFORMER DESIGN AND CONSTRUCTION	13
4.1	General	13
4.2	High Efficiency Low Loss Design	14
4.3	Loading	14
4.4	Radiators	14
4.5	Tanks and Lids	14
4.6	Joints and Gaskets	15
4.7	Core	15
4.8	Windings	15
4.8.1	Single Phase Transformers	16

4.8.2	Three Phase Transformers	16
4.8.3	Single Wire Earth Wire Return Distribution Transformers	16
4.8.4	Isolation Distribution Transformers	16
4.9	Tappings.....	16
4.10	Cooling	19
4.11	Insulating Oil.....	19
4.12	Bushings and Terminals	20
4.12.1	General	20
4.12.2	MV Bushings.....	20
4.12.3	LV Bushings.....	21
4.13	Painting	21
4.13.1	Aerial Transformers	21
4.13.2	Ground-mounted Transformers	21
4.14	Transformer Fittings	21
4.14.1	Rating Plates and Terminal Markings.....	22
4.14.2	Lifting and Transport Facilities.....	22
4.14.3	Oil Level Indicator	22
4.14.4	Earthing Bracket	22
4.14.5	Tank Markings	22
4.15	Performance Criteria	23
4.15.1	Minimum Power Efficiency (MEPS).....	23
4.15.2	Guaranteed Transformer Losses.....	23
4.15.3	Transformer Impedances.....	23
5	AERIAL TRANSFORMERS	24
5.1	General	24
5.1.1	Transformer Mounting Brackets	24
5.1.2	Surge Arrestor Brackets	24
5.1.3	LV Winding Bushings.....	25
5.1.4	MV Winding Bushings.....	25
5.1.5	Earthing.....	25
5.2	Single Phase Transformers	25
5.2.1	General	25
5.2.2	Terminal Arrangement of MV Winding.....	25
5.2.3	Additional Requirements.....	26
5.3	Three Phase Transformers	26
5.3.1	Additional Requirements.....	26
5.4	Isolation Transformers	26

5.4.1	General	26
5.4.2	Additional Requirements	27
6	GROUND-MOUNTED TRANSFORMERS	27
6.1	Supply of Packaged Substations	27
6.2	General for Packaged Substations	28
6.2.1	Physical.....	28
6.2.2	MV/LV Cubicle	28
6.2.2.1	General	28
6.2.2.2	Doors.....	29
6.2.2.3	Earthing.....	29
6.2.2.4	Neutral.....	30
6.2.3	MV Winding Bushing	30
6.2.4	Base Frame	30
6.3	Modular Packaged Substations (MPS)	30
6.3.1	General	30
6.3.2	Physical.....	30
6.3.3	MV/LV Cubicle	31
6.3.3.1	General	31
6.3.3.2	Doors.....	31
6.3.4	LV Winding Bushings.....	31
6.3.5	Low Voltage Switchgear	31
6.3.5.1	General	31
6.3.5.2	LV Switchgear Arrangement	32
6.3.5.3	Fuse Switch Disconnectors	32
6.3.5.4	Cable and Terminations	33
6.3.6	Other Technical Requirements for MPS Transformers	33
6.4	Non-Modular Packaged Substations (Non-MPS).....	34
6.4.1	General	34
6.4.2	Physical.....	34
6.4.3	MV/LV Cubicle Details	34
6.4.3.1	General	34
6.4.3.2	Doors.....	34
6.4.4	LV Windings Bushings.....	34
6.4.5	Low Voltage Fuse/MCCB	35
6.4.5.1	General	35
6.4.5.2	LV Fuse Switch Disconnecter	35
6.4.5.3	Moulded Case Circuit Breaker (MCCB).....	36
6.4.5.4	Cable and Terminations	37
6.4.6	Other Technical Requirements for Non-MPS Transformers	37

7	STORAGE	38
8	RELIABILITY	38
9	SAFETY	38
10	ENVIRONMENTAL CONSIDERATIONS	38
11	TESTS	38
11.1	Test Requirements	38
11.1.1	Type Tests	38
11.1.2	Routine and Sample Tests	39
11.1.3	Special Tests	40
11.1.4	Pressure Test.....	41
11.1.5	Witness Testing	41
12	DOCUMENTATION AND SAMPLES	41
12.1	Type Test Certificates/Reports	41
12.2	Samples	41
12.2.1	Test Samples	41
13	PACKAGING REQUIREMENTS	41
Appendix A	Revision Information	43
Appendix B	QUALITY ASSURANCE (TO BE COMPLETED BY STORES).....	44
Appendix C	SCHEDULES A & B: ENQUIRY DOCUMENT	47
Appendix D	SCHEDULE C: COMPLIANCE DOCUMENT.....	61
Appendix E	SCHEDULE D: DEPARTURES FROM TECHNICAL SPECIFICATION	65
Appendix F	SCHEDULE E: TRANSFORMER DESCRIPTION	66
Appendix G	SPECIFICATION DRAWINGS.....	72

1 SCOPE

This Specification covers Horizon Power's technical requirements for the manufacture, supply, testing and delivery of Distribution Transformers used on AC systems from 6.6 kV to 33 kV.

The specification covers Horizon Power's requirements for pole-mounted and ground-mounted distribution transformers for use in its three phase, single phase, and single wire earth wire return (SWEWR) electricity distribution systems.

Approval in terms of this specification must be obtained by one or a combination of the following:

- successful completion of the appropriate tests required by this specification by an independent and accredited test authority.
- provision of test certificates from an independent and accredited test authority based upon an alternative specification, with test requirements at least equivalent to this specification.

NOTE: Verification of accreditation of the test authority must be provided by NATA (National Association of Testing Authorities) accredited test house or by a test house possessing accreditation from a NATA MRA (Mutual Recognition Agreement) partner.

2 NORMATIVE REFERENCES

2.1 Standards

2.1.1 Horizon Power Standards

- [1] *Horizon Power Environmental Conditions*, standard number HPC-9EJ-01-0001-2013, available at <http://horizonpower.com.au/contractors-suppliers/contractors/manuals-and-standards/> under the 'Standards' heading.
- [2] *Technical Rules HPC-9DJ-01-0001-2012*, available at <http://horizonpower.com.au/contractors-suppliers/contractors/manuals-and-standards/> under the 'Technical Rules' heading.

2.1.2 Australian Standards

The following standards are available at <http://www.saiglobal.com>.

- [3] *AS/NZS 1429.1, Electric cables – Polymeric insulated – For voltages 1.9/3.3(3.6) kV up to and including 19/33(36) kV*, Standards Australia, 2006 (R2017)
- [4] *AS 1580, Paints and related materials – Methods for test*, Standards Australia, 2004
- [5] *AS 1627.0, Metal finishing – Preparation and pre-treatment of surfaces – Method selection guide*, Standards Australia, 1997 (R2017)
- [6] *AS 2067, Substations and high voltage installations exceeding 1 kV a.c.*, Standards Australia, 2016

- [7] *AS/NZS 2312.1, Guide to the protection of structural steel against atmospheric corrosion by the use of protective coatings – Paint coatings*, Standards Australia, 2014 (Amdt 1:2017)
- [8] *AS 2374.1.2, Power transformers – Minimum energy performance standard (MEPS) requirements for distribution transformers*, Standards Australia, 2003 (R2016) (Amdt 1:2005)
- [9] *AS 2629, Separable Insulated Connectors for Power Distribution Systems above 1 kV*, Standards Australia, 2008 (R2019)
- [10] *AS 2700, Colour Standards for General Purposes*, Standards Australia, 2011 (R2022)
- [11] *AS/NZS 3000, Electrical Installations (known as Australian/New Zealand Wiring Rules)*, Standards Australia, 2018 (Amdt 2:2021)
- [12] *AS/NZS 3008.1, Electrical installations – Part 1: Selection of cables. Cables for alternating voltages up to and including 0.6/1 kV – Typical Australian installation conditions*, Standards Australia, 2017
- [13] *AS/NZS 3750, Paints for Steel Structures*, Standards Australia, 2008 (R2019)
- [14] *AS 4362.1, High-voltage test techniques for low-voltage equipment – Part 1: Definitions, test and procedure requirements*, Standards Australia, 1996 (R2015)
- [15] *AS/NZS 4680, Hot dip galvanised (zinc) coatings on fabricated ferrous articles*, Standards Australia, 2006
- [16] *AS/NZS 60076.1, Power Transformers – Part 1: General*, Standards Australia, 2014
- [17] *AS/NZS 60076.3, Power Transformers – Part 3: Insulation Levels*, Standards Australia, 2017 (Amdt 1:2020)
- [18] *AS/NZS 60076.7, Power Transformers – Part 7: Loading guide for oil-immersed transformers*, Standards Australia, 2013
- [19] *AS/NZS 60076.10.1, Power Transformers – Part 10.1: Determination of sound levels-Application guide*, Standards Australia, 2009
- [20] *AS/NZS 60137, Insulated Bushings for AC Voltages above 1000 V*, Standards Australia, 2020
- [21] *AS 60214.1, Tap Changers*, Standards Australia, 2020
- [22] *AS 60296, Fluids for electrotechnical applications - Unused mineral insulating oils for transformers and switchgear*, Standards Australia, 2017
- [23] *AS/NZS 60422, Mineral insulating oils in electrical equipment – Supervision and maintenance guide*, Standards Australia, 2017
- [24] *AS/NZS 60529, Degrees of protection provided by enclosures (IP Code)*, Standards Australia, 2004
- [25] *AS/NZS 60947.1, Low Voltage Switchgear and Controlgear – General rules*, Standards Australia, 2021
- [26] *AS/NZS 60947.2, Low Voltage Switchgear and Controlgear – Circuit breakers*, Standards Australia, 2015

- [27] *AS/NZS 60947.3, Low Voltage Switchgear and Controlgear – Switches, disconnectors, switch-disconnectors and fuse-combination units*, Standards Australia, 2018
- [28] *AS/NZS 61439.1, Low-voltage switchgear and controlgear assemblies - Type-tested and partially type-tested assemblies*, Standards Australia, 2016
- [29] *AS/NZS 61439.5, Low-voltage switchgear and controlgear assemblies – Assemblies for power distribution in public networks*, Standards Australia, 2016
- [30] *AS 62271.301, High voltage switchgear and control gear – Dimensional standardisation of terminals*, Standards Australia, 2022
- [31] *ENA DOC 007, Specification for Pole-mounting Distribution Transformers*, Electricity Networks Australia, 2006
- [32] *SA TS 60815, Selection and dimensioning of high-voltage insulators intended for use in polluted conditions*, Standards Australia, 2020

2.1.3 International Standards

The following standards are available at <http://www.saiglobal.com>.

- [33] *ASTM D1275-15, Standard Test Method for Corrosive Sulphur in Electrical Insulating Liquids*, American National Standards Institute,
- [34] *IEC 60269.1, Low-voltage fuses – Part 1: General requirements*, International Electrotechnical Commission, 2014
- [35] *IEC 60812, Failure modes and effects analysis (FMEA and FMECA)*, International Electrotechnical Commission, 2018
- [36] *IEC 61099, Insulating liquids – Specification for unused synthetic organic esters for electrical purposes*, International Electrotechnical Commission, 2010
- [37] *IEC 62535, Insulating liquids – Test method for detection of potentially corrosive sulphur in used and unused insulating oil*, International Electrotechnical Commission, 2008
- [38] *IEC 62770, Fluids for electrotechnical applications – Unused natural esters for transformers and similar electrical equipment*, International Electrotechnical Commission, 2013
- [39] *IEEE SA 386, Separable Insulated Connector Systems for Power Distribution Systems Rated 2.5 kV through 35 kV*, Institute of Electrical and Electronics Engineers, 2016

2.1.4 Compliance with Standards

Various Standards are referenced in this Specification. The Standards have reference to the year they were published. If over the life of the Tender the Standards change, the Vendor is required to conform to the new edition of the Standard.

Unless otherwise specified herein, the *Equipment* shall be designed, manufactured and type and routine tested in accordance with the referenced Australian Standards, including all amendments. Where there is no Australian

Standard equivalent, International Standards or Codes as defined in this specification shall be used. The specified documents contain provisions that, through reference in the text, constitute requirements of this Specification. At the time of publication of this Specification, the editions indicated were valid. Information on currently valid national and international standards may be obtained from the Australian Standards website. <http://saiglobal.com>.

2.2 Definitions and Abbreviations

For the purposes of this specification, definitions shall apply as in the relevant Australian Standards (AS/NZS 60076.1 [16] & AS/NZS 60947.1 [25]) with the addition of a few general definitions listed below in alphabetical order.

Aerial: means equipment installed above ground to an overhead distribution system.

Dead Front: Dead front means the medium voltage terminations utilise moulded, load-break elbows, which enclose the actual termination point. See Live Front.

Equipment: means all the equipment, accessories and terminations necessary to form a Distribution Transformer meeting the technical requirements of this Specification.

Live Front: means the medium voltage terminations are bolted, with stress cones. When you open the door, the medium voltage is present at the termination point.

MCCB: Moulded Case Circuit Breaker

MPS: Modular Packaged Substation - Combination of transformer, MV cable box, and LV compartment (housing low voltage switchgear); designed for use in a residential underground distribution system

Non-MPS: Non- Modular Packaged Substation - Combination of transformer, MV cable box and LV cable box (with LV fuse/MCCB); only for use in an industrial underground distribution system

PCB: polychlorinated biphenyl, a transformer insulating fluid known to be carcinogenic

PENDA: Public Electricity Network Distribution Assemblies, Low Voltage Switchboard design and built to AS/NZS 61439.1 [28].

RMS: root mean square – an effective average for sinusoidal quantities

SWEWR: Single Wire Earth Wire Return

2.3 Drawings

The drawings listed below, are provided for information purposes, and forms part of this specification, see Appendix G:

- HPA-SD-E-00001-01 (Aerial Conn. 1 ph)
- HPA-SD-E-00002-01 (Aerial Conn. 1 ph – 2 bushings)
- HPA-SD-E-00003-01 (Aerial Conn. 3 ph – LV on side)
- HPA-SD-E-00004-01 (Aerial Conn. 3 ph – LV at back)
- HPA-SD-E-00005-01 (Aerial Conn. Isolation)

- HPA-SD-E-00006-01 (Aerial Conn. Surge Arrester Application)
- HPA-SD-E-01002-01 (Pad-mount 3 ph MPS)
- HPA-SD-E-01003-01 (Pad-mount 3 ph Non-MPS)
- HPA-SD-S-00001-01 (Aerial Bracket Mounting)
- HPA-SD-S-00017-01 (Non-MPS Cable Guard)

3 REQUIREMENTS

3.1 Power System Particulars

3.1.1 Rated Voltages

The rated voltages considered in this specification are:

- 12.7 SWER /0.240-0.480 kV (single phase)
- 19.1 SWER /0.240-0.480 kV (single phase)
- 6.38-11/0.240-0.480 kV (single phase)
- 22/0.240-0.480 kV (single phase)
- 33/0.240-0.480 kV (single phase)
- 11-6.38/0.415 kV (dual ratio primary – 3 phase)
- 22-11/0.415 kV (dual ratio primary – 3 phase)
- 22/0.415 kV (3 phase)
- 33/0.415 kV (3 phase)

3.1.2 Fault Rating

The *Equipment* must meet the requirements of HP's Technical Rules [2] and be rated to withstand:

- 31.5 kA rms for one second, for 415 V
- 21.9 kA rms for one second, for 6.6 kV
- 25.0 kA rms for one second, for 11 kV
- 16.0 kA rms for one second, for 22 kV
- 13.1 kA rms for one second, for 33 kV

3.1.3 Nominal System Frequency

The nominal system frequency is 50 Hz.

3.1.4 System Insulation Levels

The required withstand voltages as specified in AS/NZS 60076.3 [17] are as follows:

Table 1: System Insulation Levels

Nominal System Voltage (kV _{rms})	Highest voltage for equipment U _m (kV _{peak})	Lightning impulse withstand voltage (kV _{peak})	Short duration power frequency withstand voltage (kV _{rms})
Up to 3.3	3.6	40	10
6.6	7.2	75	20
11.0	12.0	110	28
12.7	24.0	150	50
19.1	36.0	200	70
22.0	24.0	150	50
33.0	36.0	200	70

3.1.5 Pollution Performance

Notwithstanding the nominal system's withstand voltages at each distribution level, the minimum system design level for insulation creepage length is 31 mm/kV as specified in AS/NZS 60137 [20] for Very Heavy pollution areas.

3.2 Service Conditions

3.2.1 Environmental Conditions

The performance of the *Equipment* must meet the requirements set out in Section 4.1 of the *Horizon Power Environmental Conditions* [1].

3.2.2 Operational Conditions

3.2.2.1 Cyclic Loading

Equipment may be loaded on a cyclic daily basis up to 1.5 times continuous maximum rating for two periods of two hours each, separated by approximately eight hours. All *Equipment* must fully satisfy the Normal Cyclic and Emergency Cycle Duty loading requirements of AS/NZS 60076.7 [18].

Any departures from the cyclic loading requirements in AS/NZS 60076.7 [18] must be listed by the Vendor in Appendix E, Departures from Technical Specification.

3.2.2.2 Cooling Criteria

Notwithstanding the maximum service ambient temperature of 55°C stated in Section 4.1 of the *Horizon Power Environmental Conditions* [1], *Equipment* must be designed to meet maximum Top Oil Temperature and Winding Temperature rises of 60°C and 65°C respectively, above an ambient temperature of 40°C.

3.2.2.3 Seismic Disturbances

The *Equipment* and associated fittings must be designed to withstand the effects of shock waves and earth movements resulting from earthquakes without failure.

The Vendor shall provide calculations or software modelling showing forces applied to the *Equipment* and its fittings under earthquake conditions in accordance with HPC-9EJ-01-0001-2013 *Horizon Power Environmental Conditions [1]*, including:

- Overturning and sliding forces.
- Bending moments at base of bushings.
- Force on bracing between core and main tank and strength of bracing.
- Details of fixing main tank to concrete plinth and strength of fixing.

3.2.2.4 Wind Loads

The Vendor must demonstrate with calculations or software modelling that the *Equipment* and associated fittings can withstand the pressure associated with the specified maximum wind gust in HPC-9EJ-01-0001-2013 *Horizon Power Environmental Conditions [1]*.

3.2.2.5 Noise

The design and construction of each transformer must be such that the sound levels are measured in accordance with the AS/NZS 60076.10.1 [19]. The sound levels must not exceed the following levels according to the stated transformer ratings:

Table 2: Sound Levels

Transformer Size	Sound Level
200 kVA and below	≤ 56.0 dB (A)
315 kVA up to 1000 kVA	≤ 65.0 dB (A)

3.2.3 Service Conditions

While the offered *Equipment* may vary in terms of dimensions and mass from those currently procured by Horizon Power, any proposed changes in the physical characteristics should be identified in Appendix E, Departures from Specifications. All material changes should also be noted where they may affect other equipment and/or an overall life cycle evaluation.

4 TRANSFORMER DESIGN AND CONSTRUCTION

4.1 General

The design and construction of the transformers and their components and parts must be fit for its intended purpose in all respects as described in this specification and applicable documents.

The transformers must be suitably stiffened and braced to prevent distortion or damage under service conditions and during handling and transport.

All sharp points on the transformer's exterior surfaces must be removed to prevent injury. All fixings must conform to Australian metric standards, and be galvanised mild steel unless otherwise specified. Compatible materials must be used for all fixings to prevent corrosion.

4.2 High Efficiency Low Loss Design

Horizon Power's regional business has historically operated under the burden of high generating costs for the electricity it distributes. Horizon Power is alert to the possibility of reductions in the life-cycle costs of Distribution Transformers through the use of developed high-efficiency transformer technologies. Horizon Power seeks to assess the life-cycle cost of (so-called) "low loss" transformer technologies in the hope of not only achieving superior energy efficiencies but of also making cost savings for its customers.

It should be clearly understood that Horizon Power has **NOT** committed to the purchase of alternative transformer designs to time-proven, industry standard distribution transformers. This transformer specification does **NOT** exclude industry standard distribution transformers.

Information and data submitted by Vendors of transformer design will be evaluated by Horizon Power with a strong focus on whole-of-life costs.

4.3 Loading

The transformers must be suitable for loading in accordance with AS/NZS 60076.7 [18]. No part of the transformer (e.g. bushings or tap changer) may impose restrictions on the loading capabilities.

4.4 Radiators

For transformers requiring cooling radiators, the radiators must be of the fin-wall type, and be welded directly into the tank sides and/or tank ends. Fins must be mechanically stabilised to the approval of Horizon Power.

Special attention must be given to ensuring that all surfaces of the fins are galvanised or painted to the same standard as the external tank surfaces. Refer to Section 4.13 for paint requirements.

4.5 Tanks and Lids

The tank shall be designed to withstand mechanical loads in accordance with Section 3.2.2.4 and be sufficiently strong to allow the *Equipment*, complete in its tank to be transported by sea, rail, sealed/unsealed roads and lifted by crane without overstraining the joints and without causing permanent deformation of the structure or subsequent leakage of insulating fluid.

All surfaces must be designed to prevent the accumulation of water. All seams will be electrically welded and oil tight.

On the external areas of the tank, welding of horizontal and vertical joints must be on both sides of the joint. Welding in all cases must be continuous.

All metal work must be electrically bonded to the tank to permit earthing by Horizon Power. If a part cannot be adequately bonded, it must be constructed from a suitable insulating material instead of metal.

The lid shall be designed to prevent collection of moisture on any part and shall be sufficiently rigid to prevent distortion when *Equipment* is being lifted.

For ground mounted *Equipment*, the lid shall be covered by a replaceable aluminium cover which acts as a sunshield and prevents water pooling in the middle of the lid.

For pole mounted *Equipment*, a stiffening bar shall be welded to the kick plate.

4.6 Joints and Gaskets

All bolted joints must be rendered oil-tight by the use of neoprene gaskets or other sealing methods. All gaskets/seals must be designed to last the life of the transformer. Joints in gaskets must not occur at bolt holes. Where tank covers are bolted rather than fully welded, the sealing method must be submitted to Horizon Power for approval.

4.7 Core

The core shall be constructed from high grade silicon steel laminations treated with an insulating material that shall not deteriorate under all operating conditions.

The Vendor shall show the drawings of internal connections and methods used to support the core to prevent movement during transport and fault.

The thermal design of the core and core frame assemblies shall prevent excessive temperatures from occurring whilst minimising the footprint and height of the *Equipment* to allow for better interchangeability.

Any core bolts and structural steel core supports shall be adequately insulated by materials that will not be adversely affected by the conditions under which it will operate throughout the life of the *Equipment*.

The core and all metalwork must be electrically bonded to the tank. The bonding of core/cores must be brought to one point only.

4.8 Windings

Vendors may offer either copper or aluminium windings.

A full description of the type of material, construction, manufacturing process including details of the drying, shrinkage, impregnating treatment and coil clamping methods of the windings shall be included in the Proposal.

Both core and winding shall be supported by the main tank and not by the lid.

HV connection to the tap switch shall be by means of bolted or crimped connections, spade type connectors are not acceptable.

4.8.1 Single Phase Transformers

Single Phase Transformers must have two low voltage windings which may be connected in series or parallel. The ends of all windings must be brought out to external bushing terminals so that either a series three-wire 480/240 volt or parallel two-wire 240 volt supply can be conveniently selected by means of pre-formed links.

The series/parallel connecting links must be supplied with the transformer. The transformer must be supplied with the links configured for 240 volt operation.

The voltage regulation of either low voltage winding must not exceed the value permitted by AS/NZS 60076.1 [16]. The voltage regulation is measured when one low voltage winding supplies load equal to half of the transformer rating, and the other low voltage winding is connected as open circuit.

4.8.2 Three Phase Transformers

Three Phase Transformers must be connected in accordance with the vector group symbol given in Table 5.

4.8.3 Single Wire Earth Wire Return Distribution Transformers

Single Wire Earth Wire Return (SWEWR) Transformers must operate with one end of the medium voltage winding connected to earth. The end of the winding to be earthed must be brought out of the tank to an earth return terminal through an adequately rated bushing. A removable tinned copper earth strap of section 20 mm x 1.5 mm or equivalent must be provided and connected between the earth return terminal and the tank.

These transformers must also comply with the requirements for Single Phase Transformers with two low voltage windings as set out in this specification.

4.8.4 Isolation Distribution Transformers

Isolation transformers must have two primary MV bushings (A1 & A2) for connection to the MV network, one MV bushing (a1) for connection to the SWEWR MV network and one LV bushing (n) for connection to earth.

4.9 Tappings

Each transformer will be capable of off-circuit tap changing by means of an externally operated seven position tapping switch complying with AS 60214.1 [21].

Seven tap positions will be provided on the high voltage winding. The tapping range for each unit will be +10% to -5% of rated voltage with a tapping step of $\pm 2.5\%$. Tap position 1 will correspond to the full winding in circuit.

The tapping switch will have a permanent overload capability of 50%, i.e. 150% of nameplate full load current of the transformer.

The tapping switch will be located near the top of the transformer for ease of access and to readily facilitate un-tanking of the transformer.

The tapping switch will be capable of being locked in every position. The locking arrangement will make it impossible to lock the switch between tap positions.

Each tapping selector switch position will be identified by a number clearly and indelibly stamped on to either the switch operating handle or the transformer tank.

The MV connection to the tapping switch must be made by means of bolted or crimped connections.

A sealing gland must be provided on the tapping selector switch operating shaft where it passes through the transformer tank to prevent any breathing or leaking along the shaft.

The tap switch handle must be UV resistant and robust. A high grade aluminium or other suitable metal that will meet the life requirement would be considered ideal.

The tapping voltages associated with the various system voltages are specified in Table 3.

Table 3: Tapping Ratios

Nominal System Primary Voltage (V)	Tap No.	Tapping Voltages (V)	No. of MV Bushings	Primary System	Secondary System	Secondary Voltage (V)
Dual Ratio 11,000 to 6,380	1	12,100-7,018	3	3 wire	4 wire multiple earthed neutral	3 Phase 415/240
	2	11,825-6,858				
	3	11,550-6,820				
	4	11,275-6,600				
	5	11,000-6,380				
	6	10,725-6,160				
	7	10,450-5,940				
11,000	1	12,100	3	3 wire	4 wire multiple earthed neutral	3 Phase 415/240
	2	11,825				
	3	11,550				
	4	11,275				
	5	11,000				
	6	10,725				
	7	10,450				

Nominal System Primary Voltage (V)	Tap No.	Tapping Voltages (V)	No. of MV Bushings	Primary System	Secondary System	Secondary Voltage (V)
12,700	1	13,970	1	2 wire (one is multiple earth neutral wire)	3 wire multiple earthed neutral	1 Phase 480/240
	2	13,652.5				
	3	13,335				
	4	13,017.5				
	5	12,700				
	6	12,382.5				
	7	12,065				
19,100	1	21,010	1	2 wire (one is multiple earth neutral wire)	3 wire multiple earthed neutral	1 Phase 480/240
	2	20,532				
	3	20,055				
	4	19,577.5				
	5	19,100				
	6	18,525				
	7	18,050				
Dual Ratio 22,000 to 11,000	1	24,200-12,100	3	3 wire	4 wire multiple earthed neutral	3 Phase 415/240
	2	23,650-11,825				
	3	23,100-11,550				
	4	22,550-11,275				
	5	22,000-11,000				
	6	21,450-10,725				
	7	20,900-10,450				
22,000	1	24,200	2	2 wire	3 wire multiple earthed neutral	1 Phase 480/240
	2	23,650				
	3	23,100				
	4	22,550				
	5	22,000				
	6	21,450				
	7	20,900				

Nominal System Primary Voltage (V)	Tap No.	Tapping Voltages (V)	No. of MV Bushings	Primary System	Secondary System	Secondary Voltage (V)
22,000	1	24,200	3	3 wire	4 wire multiple earthed neutral	3 Phase 415/240
	2	23,650				
	3	23,100				
	4	22,550				
	5	22,000				
	6	21,450				
	7	20,900				
33,000	1	36,300	2	2 wire	3 wire multiple earthed neutral	1 Phase 480/240
	2	35,475				
	3	34,650				
	4	33,825				
	5	33,000				
	6	32,175				
	7	31,350				
33,000	1	36,300	3	3 wire	4 wire multiple earthed neutral	3 Phase 415/240
	2	35,475				
	3	34,650				
	4	33,825				
	5	33,000				
	6	32,175				
	7	31,350				

For dual ratio transformers, selection of primary voltage rating must be made possible by the provision of a single external handle operating an off-circuit change switch.

4.10 Cooling

The method of cooling will be ONAN.

4.11 Insulating Oil

The transformers must be delivered filled with mineral insulating oil complying with AS 60296 [22]. The transformer oil must be proven to be non-corrosive by Method B of ASTM D1275-15 [33], and in accordance with IEC 62535 [37]. The quality of mineral Insulating oil at the time of filling must have moisture content of less than 20 ppm and a have a breakdown strength no less than 50 kV.

All insulating oil must be certified as polychlorinated biphenyl-free (PCB free). Analysis must be conducted in a laboratory certified by NATA for the appropriate analyses. The Vendor will supply full specifications and test results for the oil offered.

Fire safe natural esters complying with IEC 62770 [38] will be used in all pole mounted transformers. Pole mounted *Equipment* are not intended to be refurbished and reused once removed from service.

Ground mounted *Equipment* shall have fire safe biodegradable synthetic ester transformer oil complying with IEC 61099 [36]. Ground mounted transformers that are removed from service, within 10 years of the manufacture date, to facilitate substation upgrades or defect repairs, will be refurbished and placed back into service.

The moisture content of the fluid shall not exceed the values stated in AS 60422 [23].

The minimum breakdown voltage of the fluid shall be 40 kV.

The *Equipment* shall be delivered filled with fluid.

A data sheet of the fluid shall be submitted to Horizon Power for approval.

4.12 Bushings and Terminals

4.12.1 General

All bushings must be side wall mounted and comply with AS/NZS 60137 [20], SA TS 60815 [32] and the Service and Environmental Conditions stated in this technical specification. Where porcelain components are supplied, they must be glazed and fully vitrified. The particular requirements for bushings and terminations are detailed in Section 5.1.3, 5.1.4, 6.2.3 and 6.3.4. Details of all bushings must be submitted to Horizon Power for approval.

All terminal palms must be arranged vertically and must comply with AS 62271.301 [30]. They must be copper and their contact surfaces must be either tinned or silver plated. Both sides must be able to be used as contact surfaces.

Precautions must be taken to prevent the long-term erosion of the MV bushing gasket by leakage currents. This may be done by providing a path for leakage currents by the application of conductive paint around the perimeter of the gasket, by a metal shorting strip between the bushing side of the gasket and the tank side of the gasket or by another approved method.

Bushing placement dimensions must be in accordance with the applicable drawings in shown in Appendix G and listed in Section 2.3.

4.12.2 MV Bushings

The terminals must be marked in accordance with AS/NZS 60076.1 [16]. The use of adhesives to attach marking plates will not be accepted. Terminal palms must allow for current transformers to be fitted over them.

4.12.3 LV Bushings

The LV bushings must be mounted horizontally on the side of the transformer opposite the MV cable box or MV bushing and must be spaced to allow a bushing-mounted phase current transformer to be fitted by the Purchaser.

The part of each LV bushing within the tank must be completely covered with oil for all conditions. Bushings will be readily accessible inside the tank when an access cover is removed.

The distance between centre lines of the LV bushings will not be less than 200 mm for all ratings. The taut string metal-to-metal clearances of the bushing terminals must be not less than 100 mm phase-to-phase and 60 mm phase-to-earth.

The neutral connection to the star point on the secondary winding must be brought out of the tank unearthed and insulated, in the same manner as the phase terminals.

4.13 Painting

All internal and external surfaces must be protected against corrosion. All exposed metal surfaces must be protected by the application of a painting system, as per AS/NZS 3750 [13], at least equivalent to ISO Category 4-5 and suitable for Category E-M marine environments as specified in AS/NZS 2312.1 [7].

Preparation and pre-treatment of surfaces as per AS 1627 [5].

Colours must be to AS 2700 [10] or equivalent as detailed below:

4.13.1 Aerial Transformers

The Vendor must provide two options concerning the protection of the exterior surfaces for the Aerial Transformer:

- 1) Hot-dip Galvanising of the transformer; or
- 2) Painting of transformer with Paint Colours:
 - a) 11-6.6 kV - N42 Storm Grey;
 - b) 22 kV - N42 Storm Grey;
 - c) 33 kV – G33 Lettuce;

4.13.2 Ground-mounted Transformers

The colour of the exterior of the transformers must be as follows:

- 1) Painting of Tanks: Colour Hawthorn Green – Camtect AG692 or G11 Bottle Green
- 2) Painting of Cable Boxes and Marshalling Enclosures: Colour Hawthorn Green – Dulux 33709 or G11 Bottle Green.

4.14 Transformer Fittings

Transformers must be supplied with fittings as detailed below.

4.14.1 Rating Plates and Terminal Markings

Rating plates must be Stainless Steel and conform to Clause 7 of AS/NZS 60076.1 [16]. The plates must be clearly legible for the life of the transformer and located as indicated on the drawings in Appendix G, listed in Section 2.3. All rating plates must incorporate a diagram of connections.

4.14.2 Lifting and Transport Facilities

Rated and tested lifting lugs/eyes shall be provided to safely secure for transport, lifting, disassembly of heavy items; and shall be positioned so that lifting slings do not foul bushings or fittings.

Any specific lifting instructions shall be clearly marked on the *Equipment* adjacent to the lifting points.

Lifting lugs for pole top units shall accommodate a 60 x 40 mm hole. There shall be two (2) lifting points.

Lifting lugs for ground mount units shall accommodate a 60 x 40 mm hole. There shall be four (4) lifting points.

Lugs shall be positioned that they are suitable for connection to lifting beams and attaching slings.

4.14.3 Oil Level Indicator

The *Equipment* shall be provided with a prismatic oil level indicator located at least 50 mm above the highest bushing lead.

For MPS and Non MPS units, a dial type oil temperature indicator is to be provided in the HV cubicle. It shall be installed into a thermo pocket to allow replacement of the gauge without the need to drain oil.

The Vendor shall ensure the indicators are mounted in such a way to prevent leaks of insulating fluid or moisture ingress.

4.14.4 Earthing Bracket

A corrosion-resistant bare metal earthing bracket, sized at least 50 x 40 x 5 mm with an M14 hole drilled near the centre of the bracket, must be provided near the bottom of the tank, as close as practicable vertically below the LV neutral terminal.

The bracket must be fitted with an M12 x 40 mm Grade 316 Stainless Steel bolt, nut, locknut and two flat washers. The earth bracket must be welded vertically along the 40 x 5 mm side directly to the tank, i.e. there are to be no bolted connections in the electrical path between the bracket and the tank.

4.14.5 Tank Markings

In addition to nameplate markings, the transformer capacity and Purchaser's identification number must be stencilled in black numerals onto the tank where it can be easily seen from the ground. Each numeral must be 75 mm high and have a body width of not less than 12 mm.

DANGER signs must be fixed to the MV and LV panels of all transformers and must display the words "Danger - High Voltage".

4.15 Performance Criteria

4.15.1 Minimum Power Efficiency (MEPS)

All transformers must meet or exceed the minimum power efficiency levels specified in Table 1 of AS 2374.1.2 [8]. Transformers with efficiencies not meeting or improving performance upon these MEPS levels are unacceptable.

During the term of the Contract, the Purchaser reserves the right to negotiate with the Vendor to enhance the Transformer Power Efficiency levels to meet any future amendments to the MEPS requirement in AS 2374.1.2 [8].

4.15.2 Guaranteed Transformer Losses

In evaluating the Tenders, the Purchaser will capitalise the guaranteed losses and determine the economic advantages of the transformers offered. Transformer losses will form a major part of the proposal assessment. Capitalisation of losses will be based on the guaranteed losses, at the required power rating for each item to be provided by the Vendor as stated in Appendix C, Technical Schedules. Load losses will be calculated on the principal tapping.

The following formula will be used for the purpose of making a fair economic comparison on the Life Cycle Cost (K) of the transformer, based on the average cost of energy.

$$K = A + C_i * W_i + C_c * W_c$$

Where:

A = cost of purchasing AUD\$;

C_i = capitalised cost of no-load loss, given as **\$62,635.00/kW** *;

C_c = capitalised cost of load loss, given as **\$2,029.00/kW**;

W_i = no-load losses (iron loss), kW; and

W_c = load losses (copper loss), kW

for the transformer.

The economic life of a transformer is assumed to be 50 years.

* **NOTE:** The typical value in Australia for the value of C_i , in equation above, is between \$5,000.00 and \$7,200.00.

4.15.3 Transformer Impedances

The impedance voltage at rated current on principal tapping will be generally as specified in Tables 4 to 10.

5 AERIAL TRANSFORMERS

5.1 General

The tank must incorporate all mounting studs necessary for the fitting of an LV cable box. Where applicable, the tank will also incorporate two mounting lugs located approximately 450 mm above the bottom of the tank to permit the attachment of an LV cable support bracket.

The lid of the transformer must be capable of being removed without having to dismantle other parts of the transformer. The lid must be capable of supporting up to a person weighing 100 kg without permanent deformation.

The tank must be painted as per Section 4.13.1 or galvanised.

NOTE: Vendors to apply *ENA DOC 007, Specification for Pole-mounting Distribution Transformers [31]*, where guidance is not forthcoming in this specification for Pole-Mounted *Equipment*.

5.1.1 Transformer Mounting Brackets

All pole-mounted transformers must be equipped with standard pole-mounting brackets welded to the rear wall of the transformer tank. It must be reasonably possible to pass a body belt between the pole and the transformer tank.

The brackets and tank wall are to be of adequate strength to limit distortion, when mounted in the service position. Both the top and bottom brackets must be able to carry the total weight of the transformer separately.

In addition, two clamps and four threaded rods (M20 x 250 mm) must be supplied. Each threaded rod must be supplied with two nuts, two flat washers and one spring washer. The clamps, threaded rods, flat washers, spring washers and nuts must be hot dipped galvanised in accordance with AS 4680 [15].

Configurations and dimensions requirements are shown on drawings, provided for information purposes, in Appendix G, listed in Section 2.3.

5.1.2 Surge Arrestor Brackets

Brackets must be attached adjacent to each MV bushing to enable the Purchaser to mount surge arresters. The surge arrester brackets must be used as the connection point for the arrester earth. The brackets must have a corrosion-resistant, bare metal connecting zone which has the capability to conduct fault current through the surge arrester.

The brackets must be constructed to accommodate the mounting of polymeric surge arresters, fitted with an M12 earthing stud with a minimum exposed stud length of 45 mm. The arresters must be mounted onto the bracket either directly, or via their integral insulating bracket.

Mounting details are shown on the applicable drawings in Appendix G, listed in Section 2.3. The mounting bracket must have a length of 110 mm with the mounting hole located 20 mm from the outer end of the bracket. The mounting arrangements must be shown in dotted lines on typical general arrangement drawing submitted with the tender.

5.1.3 LV Winding Bushings

The windings must be brought out to four bushings. Connections between the outer bushings must nominally be 480 volts. The nominal voltage between outer and inner bushing must be 240 volts.

5.1.4 MV Winding Bushings

The bushings shall be porcelain and must be capable of operating under high levels of salt, dust and industrial pollution. Horizontal bushings are not acceptable. Phase markings for bushings must be clearly stencilled on the tank.

Wildlife covers shall be provided for MV bushings.

The Vendor shall submit samples of the wildlife cover for approval by the Purchaser.

5.1.5 Earthing

Pole-mounted transformers shall be earthed using a stainless-steel earth bar welded onto the tank with M14 holes. This bar shall be located near the bottom of the tank and in line with the neutral terminal which can be easily accessed.

5.2 Single Phase Transformers

5.2.1 General

Single phase transformers must also have:

- Brackets suitably fitted to permit the attachment of low voltage fuse(s).
- Five prongs fitted to permit attachment of service leads.

5.2.2 Terminal Arrangement of MV Winding

For Single MV Bushing Units, the medium voltage winding will be connected across one phase whilst the grounded end of the medium voltage winding must terminate on a stud complete with nut welded to the inside of the tank. Shown on HPA-SD-E-00001-01 drawing, provided for information purposes, in Appendix G, listed in Section 2.3.

For Two MV Bushing Units, the medium voltage winding will be connected across two phases. Shown on HPA-SD-E-00002-01 drawing, provided for information purposes, in Appendix G, listed in Section 2.3.

For Three Bushing Units (Three Phase), the primary winding will be connected across two phases. Shown on HPA-SD-E-00003-01 and HPA-SD-E-00004-01 drawings, provided for information purposes, in Appendix G, listed in Section 2.3.

For Three Bushing Units (Isolation), the primary winding will be connected across two phases and the secondary SWEWR winding must be brought out through a single MV bushing. Shown on HPA-SD-E-00005-01 drawing, provided for information purposes, in Appendix G, listed in Section 2.3.

5.2.3 Additional Requirements

Other technical requirements for single phase aerial transformers for supply to Horizon Power are tabulated in Table 4 below.

Table 4: Single Phase Aerial Transformer Requirements

Item	Details	
Winding	Double Wound	
Winding Connections	Single phase, with single MV bushing on SWEWR primary; Single phase, with two MV bushings	
Transformer Size	10 kVA 10 & 25 kVA 25 kVA	11-6.38 kV 12.7, 19.1 and 22 kV 33/0.480-0.240 kV
LV Voltage	480-240 V	
Impedance	3.3% for all types	

5.3 Three Phase Transformers

5.3.1 Additional Requirements

Other requirements for three phase aerial transformers for supply to Horizon Power are given in Table 5.

Table 5: Three Phase Aerial Transformer Requirements

Item	Details	
Winding	Double Wound	
Winding Connections	Group 3 – Delta Star Vector Group Dyn1	
Transformer Size	25 and 63 kVA 100 and 200 kVA 315 kVA	11-6.38, 22 and 33 kV 11-6.38, 22 and 33 kV 11-6.38, 22 and 33 kV
LV Voltage	415 V	
Impedance	3.3% for 25 to 63 kVA 4.0% for 100 to 315 kVA	

5.4 Isolation Transformers

5.4.1 General

Isolation transformers must have:

- 1) Double surge arrestor brackets fitted to the transformer tank. The tank and bracket must be such that the arresters, with dimensions shown in Drawing (HPA-SD-E-00005-01), can be fitted and still provide the clearances shown.
- 2) The transformer secondary winding neutral (LV) terminal with the same impulse insulation level as the primary winding.

5.4.2 Additional Requirements

Other technical requirements for isolation transformers for supply to Horizon Power are tabulated in Table 6 below.

Table 6: Isolation Transformer Requirements

Item	Details	
Winding	Double Wound	
Winding Connections	Single phase, with two MV bushings primary and single MV bushing on SWEWR secondary	
Transformer Size	63 kVA	33/19.1 and 22/12.7 kV
	200 kVA	33/19.1 and 22/12.7 kV
	315 kVA	33/19.1 and 22/12.7 kV
Impedance	3.5% for all types	

6 GROUND-MOUNTED TRANSFORMERS

6.1 Supply of Packaged Substations

Ground mounted transformers used by Horizon Power form part of single-transformer packaged substations which are supplied as integral units. Ground mounted transformers must be supplied under this specification in customised packaged substations which are similar to, but not necessarily identical to, packaged substations currently used by Horizon Power. Packaged substation units are required to provide the functional features of existing packaged substation units in all essential respects.

It is desirable that packaged substation units supplied under this specification are compatible with existing packaged substations in certain key respects. The key respects include:

- the same operating and maintenance features as existing packaged substations;
- the same arrangement of bushings;
- the same mounting heights for MV and LV cables;
- a similar overall footprint of transformer-and-MV/LV cubicle assembly.

The Vendor is requested to pay close attention to providing physical compatibility with the existing packaged substations. All points of physical incompatibility with existing substation packages should be noted in Appendix E, Departures from the Technical Specification.

It should be understood that physical variations from the existing packaged substation designs will not automatically be treated as non-compliances with this specification. Horizon Power will consider the consequences of accepting changes from the existing packaged substation designs. The Vendor's attention is drawn in this context to dimensional changes which would compromise Horizon Power's ability to replace or interchange packaged substation units.

There are three basic types of packaged substations in Horizon Power's business. The physical arrangements and key dimensions for the packaged substations are shown in Appendix G, listed in Section 2.3. The two basic types are:

- 1) Modular Packaged Substations (MPS) covered in Section 6.3.
- 2) Non-Modular Packaged Substations (Non-MPS) covered in Section 6.4.

The functional features of existing packaged substations are provided for information purposes and can be taken as representative of the existing packaged substations. Similarly, the drawings in Appendix G are provided for information purposes.

6.2 General for Packaged Substations

6.2.1 Physical

Transformer dimensions and arrangements must be generally compatible with the drawings shown in Appendix G, listed in Section 2.3.

6.2.2 MV/LV Cubicle

6.2.2.1 General

The cubicle must be of robust, weather-proof (ingress protection rating of IP56 as per AS/NZS 60529 [24]), vermin-proof and bird-proof construction. The cubicle's appearance should be unobtrusive. Exterior surfaces must have no unnecessary protrusions. The enclosure must be manufactured from aluminium sheet of alloy 5005, H34 temper. It must be securely bolted down to the hot dipped galvanised steel base. Any pop rivets used in construction must be stainless steel.

All enclosure seams (i.e. door returns, door stay location brackets, etc.) must be fully seam welded. All surfaces must be arranged to prevent the accumulation of water. All welded sections must be fully seam welded to prevent the ingress of water and corrosion. Ventilation louvers must be provided.

Protection barriers must be provided to prevent accidental physical contact by Operators with live LV terminals upon accessing the LV compartment. Preference is for transparent covers for easy identification and inspection of components without removal of such covers. Approved barriers will be hinged or removable to allow intentional access to the LV terminals for the purpose of fitting voltage and current monitoring equipment.

6.2.2.2 Doors

Double skinned doors must have a folded edge of not less than 25 mm for adequate strength and stiffness. It must not be possible to pry open the doors by inserting a screwdriver or similar object to gain access to either compartment.

Both doors will be fitted with Selectrix EMKA type three point locking system (or equivalent) with a stainless steel flush mounting handle, complete with a hasp suitable to accept a 10 mm padlock. The lock's mounting brackets must have sufficient adjustment to allow fitting of the lock without the need to pack the striker plates.

All hinges must be manufactured from SS 316 stainless steel and must have a minimum pin diameter of 10 mm.

Two stainless steel sliding barrel bolts must be provided to fasten the hinged door of MV compartment to prevent inadvertent opening. The bolts must be located such that they may only be operated from within the LV compartment.

A robust door restraint/stay must be provided to hold each door in the 120° open position. The restraint must use a captive design so that it cannot be inadvertently disengaged. The restraint must be self-storing in the sense that it will prevent a closed door from rattling.

6.2.2.3 Earthing

Earthing for ground mounted transformers shall consist of two solid earth bars, tinned copper with a minimum cross-sectional area of 100 mm², insulated from the enclosure or metallic framework via stand-off insulators with one installed in the MV and LV compartments respectively. Standoff insulators shall be rated to withstand the highest voltage to earth i.e. 19.1 kV for 3 seconds.

The earth bars must be provided with a sufficient number of holes spaced 50 mm apart to suit M12 bolts for the purpose of connecting cable earths. Position of the earth bars must provide ample clearances to terminals.

The transformer earth stud, as well as all metal work including panels, doors and lids shall be electrically bonded to the MV earth bar. If a part cannot be adequately bonded, it must be constructed from a suitable insulating material. Earth straps on doors must allow the doors to open 180°.

Lift off doors shall be earthed via the hinges and type tests in accordance with AS/NZS 61439.1 [28] shall be done to confirm effective earth continuity between exposed conductive parts of the assembly and the protective earth circuit.

All flexible earthing links and connectors, including flexible earth straps to doors, must be tinned copper with a minimum cross-sectional area as stipulated in AS 2067 [6]. Flexible earthing links, cables and connectors must be stranded with striped green/yellow PVC insulation. The material and cross-sectional area of the flexible links must be shown on tender drawings.

All earthing connections must be made with bolted lug connectors, using SS316 stainless steel M12 bolts, nuts and washers.

6.2.2.4 Neutral

One neutral bar shall be installed above the LV earth bar in the LV compartment. The bar shall be solid tinned copper with a minimum cross-sectional area of 100 mm², insulated from the enclosure or metallic framework via stand-off insulators.

The neutral bar must be provided with a sufficient number of holes spaced 50 mm apart to suit M12 bolts for the purpose of connecting LV cable neutrals. Position of the neutral bar must provide ample clearances to LV terminals.

A cable, rating as determined by the Vendor, shall be installed between the neutral bushing and the neutral bar. All connections must be made with bolted lug connectors, using SS316 stainless steel M12 bolts, nuts and washers.

A removable link between the LV neutral and LV earth bars must be supplied and fitted by the Vendor. The Neutral to Earth link shall be easily accessible, removable for testing (with all cables terminated and clamped in place) and labelled.

6.2.3 MV Winding Bushing

The packaged substation must incorporate "Dead Front" MV bushings of the dead break separable connector type according to AS 2629 [9] and IEEE 386 [39]. MV bushings and connectors shall be adequately screened to be touch safe.

Transformers are to be supplied complete with bushing wells and inserts suitable for connection to elbow terminations. The bushing wells must be 200 A, 150 kVp BIL, or equivalent, and the inserts must be:

- Elastimold 25 kV, 200 A, for 22 kV primary transformers, or
- Elastimold 35 kV, 200 A, for 33 kV primary transformers

or equivalent, in accordance with IEEE 386 [39]. The arrangements, mounting heights above ground and clearances must be as shown in the applicable drawings in Appendix G.

6.2.4 Base Frame

The hot dipped galvanised base, suitable for anchoring to plinth, must be fabricated from steel RHS (Rolled Hollow Section).

6.3 Modular Packaged Substations (MPS)

6.3.1 General

A Modular Packaged Substation (MPS) includes: a distribution transformer; an integral MV/LV cubicle, with an LV compartment housing LV switchgear, and a MV compartment enclosing MV bushing wells; a steel base assembly; a lid over the transformer; cabling and related accessory items.

6.3.2 Physical

Transformers rated 160 kVA to 630 kVA must be designed such that any size will fit onto the standard hot dipped galvanised base. It should be possible to change out a packaged substation unit with a minimum of effort.

MPS Packaged Substations should be suitable for mounting on a concrete floor, or on an inverted rectangular culvert as indicated on the drawings.

The MV and LV terminations must be located on the same side of the tank, with the LV terminations positioned on the left-hand side when viewed from the front of the MV/LV cubicle, as shown on HPA-SD-E-01002-01 drawing, provided for information purposes, in Appendix G, listed in Section 2.3.

6.3.3 MV/LV Cubicle

Besides the requirements set out in Section 6.2.2 the following must be included for MPS types.

6.3.3.1 General

The spacing of all adjacent parts in the cubicle must allow reasonable room for safe inspection, cleaning, painting and operation in service.

6.3.3.2 Doors

Two hinged doors must be provided for access to the MV and LV compartments of the cubicle, for the purposes of operating and/or maintaining LV switchgear and removing of cable terminations or MV non-load break connectors. The bottom edges of the doors must be a minimum of 30 mm above the under base surface.

6.3.4 LV Winding Bushings

The terminals of 415 V windings must be brought out through bushings, the height and arrangement of bushings and the bushing cap dimensions must be as indicated on the applicable drawings in Appendix G. The neutral connection must be located in the low voltage compartment.

6.3.5 Low Voltage Switchgear

6.3.5.1 General

The packaged substation must incorporate a low voltage switchboard. Suitable connecting cables as per AS/NZS 1429.1 [3], rated in accordance AS/NZS 3008.1 [12], based on the highest internal operating temperature of the enclosure, must be supplied and installed between the transformer terminals and the LV switchboard to suit the overload capability of the transformer. Calculations to be provided upon request. Phasing must be connected A-A, B-B, C-C, N-N.

It is preferred that the connection between the transformer LV bushings and the incoming terminals of the main three phase ganged fused switch, is via cables that are suitably clamped into place. A bottom cable entry into the fused switch is preferred. LV switchgear must be mounted vertically on a common busbar system. The phase of LV busbars shall be easily identified by colours or lettering and have captive nuts to allow switchgear to be replaced without the need of a tool to hold the nut. Busbars must be sized in all cases to accommodate a 630 kVA transformer subject to cyclic overloading as described in Section 3.2.2.1.

The characteristics of the equipment, constructional and performance requirements, markings and tests must comply with AS/NZS 60947.3 [27] and AS/NZS 61439.1 [28]. Clearances, creepage and isolating distances must comply with AS/NZS 3000 [11] and AS/NZS 61439.5 [29].

The layout of the switchboard must ensure safe work practices for maintenance and operating purposes. The LV insulation level shall meet the requirement of Section 10.9.4 of AS/NZS 61439.1 [28] between phases, adjacent circuits, and protective covers. The layout is subject to the approval of Horizon Power.

6.3.5.2 LV Switchgear Arrangement

The LV switchgear shall be constructed in accordance with AS/NZS 61439.1 [28], AS/NZS 61439.5 [29] and shall consist of:

- 1) One (1) 1600 A three phase ganged, fused switch with an AC 22B rating to match 630 kVA capability - located on the right hand side of the LV Switchboard when viewed from the front of the switchboard.
- 2) Five (5) 630 A three phase ganged, fuse-switches that shall accept two cable cores, per phase terminated from the front. The fused switches shall accommodate up to 400 A DIN standard NH2/NH3 fuses for outgoing street circuits.
- 3) One (1) three phase fused switch to accommodate up to 32 A DIN standard NH00 fuses; to be used as a street light circuit supply.
- 4) One (1) 910 A or 1000 A fuse switch to accommodate up to 630 A DIN standard NH3/NH4 fuses to be used for the connection of an emergency response generator to supply the load side bus bar.

They must be "WEBER" type switchgear or an approved equivalent and shall be designed and tested in accordance with AS/NZS 60947.3 [27], be robust and proven in service.

6.3.5.3 Fuse Switch Disconnectors

The fuse switch disconnectors shall have the following:

- 1) Lockable operating handle
- 2) Suitable for NH2 an NH3 HRC fuses from 32 A to 630 A
- 3) Sized so the nominal current rating does not limit the cyclic loading capability of the equipment
- 4) Utilisation category of AC-22B
- 5) Suitable for operation under nominal voltage of 415 V and be capable of a service short circuit breaking capacity of 25 kA
- 6) Provision for LV cable shorting/earthing

Facilities shall be provided to allow circuits to be barriered and preferably locked once fuses that been removed and provision for the fuses to be housed for future use whilst the circuit is out of service.

Earth studs, for use with a portable earthing kit shall be provided in accordance with Section 4.2. They shall be installed on the line side of the incoming switch disconnector and load side of each outgoing fuse switch. These are not required on the generator and auxiliary supply fuse switches.

The switchgear shall have integral voltage test points. The tests performed will be for phase-to-phase and phase-to-neutral voltages, and to perform a phasing out operation, (i.e. checking phase rotation and voltages across the open point to be closed by the link).

All solid insulating materials used shall be fire resistant. They must not ignite spontaneously and must cease to smoulder or melt upon removal of the heat source.

It is preferred that the design of the fuse switches and switch disconnectors can be easily replaced on site, with insulated tools, whilst the equipment is live without the need to dismantle the switchgear assembly.

6.3.5.4 Cable and Terminations

It is intended that the aluminium cables as per AS/NZS 1429.1 [3] will be connected to copper busbar tabs. It is essential that sufficient space is provided for all bi-metal copper-aluminium terminations, and that appropriate connection methods are used. An insulation level of 2.5 kV rms shall be maintained between phases of each unit and adjacent units when the switch is terminated with uncovered lugs to suit the maximum cable size. Insulating barriers of fire-resistant material will be acceptable for this purpose.

Each three-phase feeder circuit must have terminals suitable for terminating cables up to 1 x 240 mm² aluminium cables per phase. LV feeder cables must be front connecting. SS316 stainless steel bolts, nuts and Belleville washers must be provided for internal and outgoing LV cable terminations. Cable connections shall ideally have captive slide nuts and phase barriers to allow cable terminations to be done live. Cable connection tabs must be drilled to suit M12 bolts.

6.3.6 Other Technical Requirements for MPS Transformers

Other technical requirements for transformers supplied in Modular Packaged Substations are given in Table 7 below:

Table 7: MPS Transformer Requirements

Item	Details	
Transformer Size	160 kVA	11-6.38, 22 and 33 kV
	315 kVA	11-6.38, 22 and 33 kV
	630 kVA	11-6.38, 22 and 33 kV
LV Voltage	415 V	
Impedance	4.0% for 160 to 630 kVA	

6.4 Non-Modular Packaged Substations (Non-MPS)

6.4.1 General

A Non-Modular Packaged Substation (Non-MPS) includes: a distribution transformer; an integral MV/LV cubicle with an LV compartment housing LV fuse/MCCB and a MV compartment enclosing MV bushing wells; a steel base assembly; a lid over the transformer; cabling and related accessory items.

6.4.2 Physical

Transformers rated 160 kVA to 1000 kVA must be designed such that any size will fit onto the standard hot dipped galvanised base. It should be possible to change out a packaged substation unit with a minimum of effort.

Non-MPS Packaged Substations should be suitable for mounting on a concrete floor, or on an inverted rectangular culvert as indicated on the drawings.

The MV and LV terminations must be located on the same side of the tank, with the LV terminations positioned on the left-hand side when viewed from the front of the MV/LV cubicle.

6.4.3 MV/LV Cubicle Details

Besides the requirements set out in Section 6.2.2, the following must be included for Non-MPS types.

6.4.3.1 General

Refer to Section 6.3.3.1.

Vendor to provide a removable cable guard as an option that must be fitted to the bottom of the MV/LV compartment for cable protection when the transformer is used outdoors. Shown on HPA-SD-S-00017-01 drawing, provided for information purposes, in Appendix G, listed in Section 2.3.

6.4.3.2 Doors

Two hinged doors must be provided for access to the MV and LV compartments of the cubicle, for the purposes of operating and/or maintaining LV switchgear and removing of cable terminations or MV dead break connectors. The bottom edges of the doors must be a minimum of 30 mm above the base.

6.4.4 LV Windings Bushings

Refer to Section 6.3.4.

6.4.5 Low Voltage Fuse/MCCB

6.4.5.1 General

The packaged substation must incorporate a low voltage protection device either a fuse as per IEC 60269.1 [34] or MCCB as per AS/NZS 60947.2 [26] suitably rated and shall comply with Section 6.3.6 and 6.4.6 respectively. Suitable connecting busbars/cables as per AS/NZS 1429.1 [3] and AS/NZS 3008.1 [12] must be supplied and installed between the transformer terminals and the LV protection device to suit the overload capability of the transformer. Phasing must be connected A-A, B-B, C-C, N-N.

The protection device (fuse/MCCB) must be mounted vertically with see through shielding preventing access to the LV equipment. Protected test points to be provided both above and below the protection device. The rating of the protection device for the 160/315/630/1000 kVA transformers must at least be 400/630/1600/2500 amps respectively.

Insulated escutcheon panel that is easy to remove for maintenance and inspection. Ideally the escutcheon shall be clear to allow visual inspection without removing it. All solid insulating materials used must be fire resistant. They must not ignite spontaneously and must cease to smoulder or melt upon removal of the heat source.

Phase coloured heat shrink on conductive parts wherever possible.

Type tested and approved earth ferrule earth stubs in accordance with Section 4.2 and voltage test points to be fitted on the line and load side of the FSD/MCCB that are accessible via a tool when the insulated escutcheon panel is in situ. It must be possible to measure phase-to-phase and phase-to-neutral voltages and also test across open FSD links and MCCB for correct phasing.

The characteristics of the equipment, constructional and performance requirements, markings and tests must comply with AS/NZS 60947.3 [27] and AS/NZS 61439.1 [28]. Clearances, creepage and isolating distances must comply with AS/NZS 3000 [11] and AS/NZS 61439.5 [29].

The layout of the switchboard must ensure safe work practices for maintenance and operating purposes. The LV insulation level shall meet the requirement of Section 10.9.4 of AS/NZS 61439.1 [28] between phases and protective covers.

The design of the 160 kVA, 315 kVA and 630 kVA shall facilitate the upgrade to 315 kVA, 630 kVA and 1 MVA respectively without the need to cut, change, extend or re-terminate MV and LV cables. The same cables and termination kits are used by Horizon Power on all installations.

6.4.5.2 LV Fuse Switch Disconnecter

The fuse switch disconnectors shall have the following:

- 1) Lockable operating handle
- 2) Suitable for NH2 and NH3 HRC fuses from 32 A to 630 A

- 3) Sized so the nominal current rating does not limit the cyclic loading capability of the equipment
- 4) Utilisation category of AC-22B
- 5) Suitable for operation under nominal voltage of 415 V and be capable of a service short circuit breaking capacity of 25 kA
- 6) Provision for LV cable shorting/earthing

An earth stud shall be installed on the load side of fuse switch, for use with a portable earthing kit shall be provided in accordance with Section 4.2.

Provision for circuit to be barriered and preferably locked once fuses have been removed and provision for the fuses to be housed for future use whilst the circuit is out of service.

The fuse switch disconnecter must be "WEBER" type switchgear or an approved equivalent and shall be designed and tested in accordance with AS/NZS 60947.3 [27], be robust and proven in service.

6.4.5.3 Moulded Case Circuit Breaker (MCCB)

The MCCB shall have the following features:

- 1) Positive (or direct) opening operation where the toggle position always matches the position of the main contacts
- 2) Lockable operating handle
- 3) Mounting position for operating handle (extension) and locking mechanism of MCCB
- 4) The size of the MCCB is to be selected so that the current rating of the circuit breaker does not limit the cyclic loading capability of the transformer. This rating of the MCCB is to be after de-rating for the higher internal ambient temperature within the Non MPS transformer LV cable compartment that is experienced during summer peak
- 5) The MCCB is to have the following protection functions (as a minimum) provided from an integrated, adjustable self-powered electronic protection unit:
 - a) Overload
 - b) Delayed short circuit
 - c) Instantaneous protection
 - d) Function G (earth fault and neutral protection)
- 6) The MCCB shall come with a 24 V ac shunt trip coil to enable remote tripping via the RTU located in the secondary systems compartment
- 7) As a minimum the MCCB shall be suitable for operation under the following network conditions:
 - a) Nominal operating voltage 415 V

- b) Service short-circuit breaking capacity 50 kA (minimum)
- 8) The MCCBs nominated by Horizon Power are:
 - a) Terasaki Tembreak
 - b) Schneider NS

An earth stud shall be installed on the load side of fuse switch, for use with a portable earthing kit shall be provided in accordance with Section 4.2.

6.4.5.4 Cable and Terminations

It is intended that the copper cables as per AS/NZS 1429.1 [3] will be connected to copper busbar tabs. It is essential that sufficient space is provided for terminations, and that appropriate connection methods are used. An insulation level of 2.5 kV rms shall be maintained between phases of each unit and adjacent units when the switch is terminated with uncovered lugs to suit the maximum cable size. Insulating barriers of fire-resistant material will be acceptable for this purpose.

The terminals suitable for terminating cables up to 3 x 400 mm² copper cables per phase for the 1000 kVA, or 2 x 400 mm² copper cable per phase. LV cable must be front connecting. SS316 stainless steel bolts, nuts and Belleville washers must be provided for LV cable terminations. Cable connections shall ideally have captive slide nuts and phase barriers to allow cable terminations to be done live. Cable connection tabs must be drilled to suit M12 bolts.

6.4.6 Other Technical Requirements for Non-MPS Transformers

Other technical requirements for transformers supplied in Non-MPS substations are given in Table 8 below.

Table 8: Non-MPS Transformer Requirements

Item	Details	
Transformer Size	160 kVA	11-6.38, 22 and 33 kV
	315 kVA	11-6.38, 22 and 33 kV
	630 kVA	11-6.38, 22 and 33 kV
	1000 kVA	11-6.38, 22 and 33 kV
LV Voltage	415 V	
Impedance	4.0% for 160 to 630 kVA	
	6.0% for 1000 kVA	

7 STORAGE

Equipment must be capable of being stored without deterioration within the temperature range of -10°C to + 45°C for at least 24 months.

8 RELIABILITY

Vendors must provide information on the reliability of the *Equipment* and the performance of the materials offered over an **operational life of 45 years** under the specified field of application and conditions of service.

Information provided must evidence the claimed reliability and performance for the *Equipment* offered, including information on Failure Mode and Effect Analysis, carried out in accordance with IEC 60812 [35]. Failure modes should be described; taking cantilever mechanical failure as an example, the failure may be excessive deflection, or brittle fracture. Electrical failure may be material damage such as puncture, polymer degradation, carbonisation, loss of hydrophobicity, etc.

Vendors may offer their standard *Equipment* but any variation to the foregoing standards must be clearly stated in writing at the time of the proposal. The products offered in the standing offer should be equal to or better in quality and performance than the existing items as listed under this Specification.

9 SAFETY

Material Safety Data Sheets (MSDS) applicable for each different *Equipment* or chemical ingredient in the *Equipment* which is considered harmful to personnel or environment in any manner, must be supplied with the Proposal.

10 ENVIRONMENTAL CONSIDERATIONS

Vendors must provide information on the environmental soundness of the design and the materials used in the manufacture of the *Equipment* offered. In particular, information must address such issues as recyclability and disposability at the end of service life as well as disposability of materials supplied.

11 TESTS

11.1 Test Requirements

The Vendor must, prior to first Delivery, complete the type, routine, special and pressure tests and inspections as required by the relevant Australian Standards including AS/NZS 60076.1 [16], on the first of each unit manufactured. Test certificates must be forwarded to Horizon Power with the dispatch of each unit.

The passing of such tests will not prejudice the right of Horizon Power to reject the *Equipment*, if it does not comply with the Specification when installed.

11.1.1 Type Tests

The actual transformers to be tested will be selected at random by Horizon Power or its agent during works testing of any batch. Horizon Power reserves the right to witness Type Tests and must be given advance notice (10 business days minimum) by the Vendor to be available to witness such tests.

The additional costs of each of these tests must be separately detailed in the Proposal together with the Testing Authority that will carry out the tests.

Type Testing must be undertaken by a NATA (National Association of Testing Authorities) accredited test house or by a test house possessing accreditation from a NATA MRA (Mutual Recognition Agreement) partner. A formal report covering the outcome of the testing must be made available to Horizon Power.

The following type tests as specified in AS/NZS 60076.1 [16] must be conducted on each transformer design.

- 1) Cyclonic Rating Test
- 2) Temperature Rise Test
- 3) Dielectric Type Tests
- 4) Tank Stiffness Test

In addition, Horizon Power may select one of each listed item, to be submitted for Impulse Testing in accordance with AS/NZS 60076.3 [17]. This requirement may, at the discretion of Horizon Power, apply to any batch of transformers on any order placed under the Contract.

Type tests for the installed LV switchboard and associated assemblies shall be conducted as per AS 4362.1 [14], if not provided by LV Switchboard supplier, covering:

- 1) Temperature Rise
- 2) Dielectric
- 3) Short-circuit Resistance
- 4) Effectiveness of the Protection Device
- 5) Clearance and Creepage Distances
- 6) Mechanical Operation

NOTE: Vendor to supply LV Switchboard type tests along with transformer type tests where applicable.

11.1.2 Routine and Sample Tests

Horizon Power reserves the right to witness an agreed program of Routine Tests to assure of the competence of the manufacturing facility to deliver consistently conforming *Equipment*. The Vendor must in all cases make all necessary provisions with the testing and/or manufacturing facilities to enable witnessing to take place. An Inspection and Test Plan (ITP) must be provided to Horizon Power prior to the witnessing of tests.

Prior to first delivery of *Equipment*, the Vendor must submit to Horizon Power all routine and sample tests performed on that batch of *Equipment*.

Routine tests must be carried out in accordance with AS/NZS 60076.1 [16] for each transformer at the Vendor's Works before dispatch to ensure that all parts operate correctly. The following tests as specified in AS/NZS 60076.1 [16] must be carried out as a minimum.

- Measurement of Winding Resistance
- Ratio and Phase Relationship Checks
- Impedance Voltage, Short Circuit Impedance & Load Losses
- No-Load Loss and Currents
- Induced Over-Voltage Withstand
- Separate-source Voltage Withstand
- Insulation Resistance
- Pressure Test on Sealed Transformers
- Measurement of Paint thickness as per AS 1580 [4]

Routine tests for the installed LV switchboard and associated assemblies shall be conducted as per AS 4362.1 [14], if not provided by LV Switchboard supplier, covering:

- 1) Insulation Resistance
- 2) Dielectric
- 3) Continuity

NOTE: Vendor to supply LV Switchboard routine tests along with transformer routine tests where applicable.

11.1.3 Special Tests

Special Tests which are applicable to all transformers are:

- Sound Level Tests
- Short Circuit Tests
- Partial Discharge

Horizon Power may select one of any of the listed transformers, to be submitted for the above Special Tests in accordance with AS/NZS 60076.1 [16]. This requirement may, at the discretion of Horizon Power, apply to any batch of transformers on any order placed under the Contract.

The actual transformers to be tested will be selected at random by Horizon Power or its agent during works testing of any batch. The additional costs of each of these tests must be separately detailed in the Proposal together with the Testing Authority that will carry out the tests. Copies of all such test results must be forwarded to Horizon Power.

11.1.4 Pressure Test

Tests must be done on sealed transformers to prove that the tank has been suitably designed and has been sealed after the successful completion of Routine Tests. The requirements for pressure testing are:

- Establish and monitor an internal pressure equal to the maximum pressure stated on the rating plate.
- If after two hours the pressure has not dropped more than 4 kPa, the transformer will be considered to have passed the test.
- Ambient temperature variation must be held within $\pm 5^{\circ}\text{C}$ through the course of the pressure test.

11.1.5 Witness Testing

The Purchaser reserves the right to witness all type tests and randomly witness routine testing. Where applicable, the Vendor must give the Purchaser not less than 10 business days' notice before a type test or routine test will be carried out.

12 DOCUMENTATION AND SAMPLES

12.1 Type Test Certificates/Reports

Test certificates, test reports or any other supporting documents supplied as evidence for compliance to relevant standards must be made available in English for review by Horizon Power.

12.2 Samples

Any deviations between the *Equipment* supplied as a sample to Horizon Power and the *Equipment* offered in the Proposal must be detailed by the Vendor.

12.2.1 Test Samples

For the purpose of evaluation, test samples of the *Equipment* may be requested by Horizon Power. Each sample must be labelled with a robust tag stating:

- Vendor Name;
- *Equipment* Number;
- Stock Code; and

When requested, the Vendor must supply Horizon Power test samples free of charge and within four weeks of the request.

13 PACKAGING REQUIREMENTS

The *Equipment* must be suitably packaged, such that it is "fit for its intended purpose" at any location in Horizon Power's operational area. Packaging must be capable of preventing damage whilst in storage and during transit to remote locations. The Vendor is required to nominate standard pack quantities and standard packs must be clearly marked with the following information:

- Manufacturer's name
- Manufacturer's part reference number
- Batch Number
- Horizon Power Order Number
- Horizon Power Stock Number

Very strong consideration will be given to appropriate packaging provided with any *Equipment* offered under this specification, with respects to satisfying the "fit for its intended purpose" criteria mentioned above.

APPENDIX A REVISION INFORMATION

(Informative) Horizon Power has endeavoured to provide standards of the highest quality and would appreciate notification of errors or queries.

Each Standard makes use of its own comment sheet which is maintained throughout the life of the standard, which lists all comments made by stakeholders regarding the standard.

A comment sheet found in **DM# 1786855** can be used to record any errors or queries found in or pertaining to this standard. This comment sheet will be referred to each time the standard is updated.

Date	Rev No.	Notes
28/05/2013	0	First Issue
20/01/2017	1	Reformatted and reconfirmed: referenced standards updated in Section 2.1, IP56 requirement added to Section 6.2.2.1, BIL changed to Lightning Impulse Withstand Voltage
28/07/2023	2	Updated to latest standards, reformatting of references, inclusion of fuse/MCCB for Non-MPS and inclusion of PENDA LV switchgear, remove SPUDS and Pad-mount Isolation transformers, remove requirement for anti-graffiti paint

APPENDIX B QUALITY ASSURANCE (TO BE COMPLETED BY STORES)

DOCUMENT NUMBER		HPC-8DJ-07-0001-2013					QUALITY ASSURANCE		DM NUMBER	
DEVICE DESCRIPTION		LABEL MATERIAL NO.					EQUIPMENT PURCHASE		ASSET OWNER	
		ASSET ID/ STOCK NO								
MANUFACTURER					DIMENSION					
ITEM	OPERATION/EQUIPMENT/FACILITY			DOCUMENT REF.	WHO CHECKS	INITIAL	DATE/ TIME	QUALITY ASSURANCE CRITERIA	PASS Y/N	COMMENTS
1										
1.1	Name of Manufacturer							*****		
1.2	Week & Year of Manufacture							*****		
1.3	Horizon Power Order Number							*****		
1.4	Horizon Power Stock Number							*****		
1.5	Name Plate							Legible		
1.6	Physical Appearance									
1.6.1	Paint Colour/Galvanising							Aerial – Galvanised or N42 Storm Grey (11 & 22 kV), G33 Lettuce (33kV) Ground Mount – Hawthorn Green Tanks – Camtect AG692 Cable Boxes & Marshalling Enclosures – Dulux 33709		

1.6.2	Paint/Galvanising Chips					*****		
1.6.3	Physical Damage					*****		
1.6.4	Oil Leaks					*****		
1.6.4	Oil Level (if applicable/visible)					Full		
1.6.5	Bushings					*****		
1.6.6	Door Appearance (if applicable)					*****		
1.7	Earth Stud					Stainless steel M12 bolt, nut, lock nut and two flat washers		
1.8	Mounting Brackets on Aerial Transformer					Two clamps and four threaded rods (M20 x 250 mm). Each threaded rod must have two nuts, two flat washers and one spring washer.		
1.9	Packaging							
1.9.1	Aerial Transformers					Box Crated on pallet with plastic stretch wrap covering		
1.9.2	Ground Mounted					Plastic stretch wrap covering and pallet (if required)		
1.10	Batch No					*****		
2	DOCUMENTATION							
2.1	Material Safety Data Sheets					Clear, Legible and in English		
2.2	Transformer Documentation & Drawings					Clear, Legible and in English		
2.3	Test and Inspection Reports					Clear, Legible and in English		

SYMBOLS AND ABBREVIATIONS								
H = HOLD POINT	S = SUPERVISOR							
W = WITNESS POINT	T = TECHNICIAN, EL = ELECTRICIAN	REVISION						
V = VERIFICATION POINT	E = ENGINEER	DATE						
S/C = SUBCONTRACTOR	PM = PROJECT MANAGER	APPROVED BY						

APPENDIX C SCHEDULES A & B: ENQUIRY DOCUMENT

	SPECIFICATION ENQUIRY	HPC-8DJ-03-0004-2013
	VENDOR'S NAME	
	DATE	

TECHNICAL SCHEDULES A & B

ITEM 1: Single Phase Aerial Transformers

VOLTAGE (kV)	11/6.38	12.7	19.1	22	12.7	19.1	22	33
ITEM	1.1	1.2	1.3	1.4	1.5	1.6	1.7	1.8
SIZE (kVA)	10	10	10	10	25	25	25	25

SCHEDULE A: Horizon Power's specific requirements

SCHEDULE B: Particulars of equipment to be supplied (to be completed by Vendor)

No	Clause	Description	Schedule A	Schedule B
		Distribution Standard Buyers Guide drawing	HPA-SD-E-#00001-01	xxxx
1		General		
1.1		Manufacturer		
1.2		Brand / Catalogue No. / Model		
1.3		Country of Manufacture		
2		Dimensions		
2.1		Width (mm)		
2.2		Height (mm)		
2.3		Depth (mm)		
2.4		Mass (kg)		
3		Particulars of Plant		
3.1		Rated Primary Voltage (kV)		
3.2		Rated Power (kVA)		
3.3		Number of Tap Positions		
3.4		Tap Step Size (%)		
3.5		Vector Group		
3.6		Quantity of oil (Litres)		
3.7		MV Bushings		
3.7.1		Manufacturer		
3.7.2		Type		
3.7.3		Creepage Length (mm)		
3.7.4		Basic Impulse Level (BIL)		
3.8		LV Bushings		
3.8.1		Manufacturer		
3.8.2		Type		
3.8.3		Basic Impulse Level (BIL)		

PUBLIC

3.9		Minimum Clearance between external live metal parts		
3.9.1		Phase to Phase (MV) (mm)		
3.9.2		Phase to Earth (MV) (mm)		
3.9.3		Phase to Phase (LV) (mm)		
3.9.4		Phase to Earth (LV) (mm)		
4		Guaranteed Performance		
4.1		No load Voltage ratio corresponding to Nominal Tap Position		
4.2		No load Loss (Watts)		
4.3		Magnetising Current (%)		
4.4		Load Loss on Nominal tap position with nominal primary voltage applied (Watts)		
4.5		Impedance Voltage on Nominal tap position and Nominal Voltage (%)		
4.6		Reactance Voltage on Nominal tap position and Nominal Voltage (%)		
4.7		Resistance Voltage on Nominal tap position and Nominal Voltage (%)		
4.8		Zero Phase Sequence Impedance (Ohm/Phase)		
4.9		Regulation		
4.9.1		• At Full Load and 1.0 PF		
4.9.2		• At Full Load and 0.8 PF		
4.10		Efficiency at Full Load and 1.0 PF		
4.11		Maximum Winding Temperature Rise (°C)		
4.12		Maximum Top Oil Temperature Rise (°C)		
4.13		Noise Level dB(A)		
4.14		Maximum Symmetrical Short Circuit Current withstand for 2 seconds (Three and Two phase) (A)		
4.15		Maximum Earth Fault Current withstand for 2 seconds (Single Phase) (A)		
4.16		Lightning Impulse Withstand Voltage (kV peak)		
4.17		Power Frequency Withstand Voltage (kV RMS)		
4.18		Life Cycle Cost 'K'		

PUBLIC

	SPECIFICATION ENQUIRY	HPC-8DJ-03-0004-2013
	VENDOR'S NAME	
	DATE	

TECHNICAL SCHEDULES A & B

ITEM 2: Three Phase Aerial Transformers

VOLTAGE (kV)	11/6.38	22	33	11/6.38	22	33					
ITEM	2.1	2.2	2.3	2.4	2.5	2.6					
SIZE (kVA)	25	25	25	63	63	63					

SCHEDULE A: Horizon Power's specific requirements

SCHEDULE B: Particulars of equipment to be supplied (to be completed by Vendor)

No	Clause	Description	Schedule A	Schedule B
		Distribution Standard Buyers Guide drawing	HPA-SD-E-00003-01	xxxx
1		General		
1.1		Manufacturer		
1.2		Brand / Catalogue No. / Model		
1.3		Country of Manufacture		
2		Dimensions		
2.1		Width (mm)		
2.2		Height (mm)		
2.3		Depth (mm)		
2.4		Mass (kg)		
3		Particulars of Plant		
3.1		Rated Primary Voltage (kV)		
3.2		Rated Power (kVA)		
3.3		Number of Tap Positions		
3.4		Tap Step Size (%)		
3.5		Vector Group		
3.6		Quantity of oil (Litres)		
3.7		MV Bushings		
3.7.1		Manufacturer		
3.7.2		Type		
3.7.3		Creepage Length (mm)		
3.7.4		Lightning Impulse Withstand Voltage (kVp)		
3.8		LV Bushings		
3.8.1		Manufacturer		
3.8.2		Type		
3.8.3		Lightning Impulse Withstand Voltage (kVp)		
3.9		Minimum Clearance between external live metal parts		
3.9.1		Phase to Phase (MV) (mm)		
3.9.2		Phase to Earth (MV) (mm)		
3.9.3		Phase to Phase (LV) (mm)		
3.9.4		Phase to Earth (LV) (mm)		

PUBLIC

4	Guaranteed Performance		
4.1	No load Voltage ratio corresponding to Nominal Tap Position		
4.2	No load Loss (Watts)		
4.3	Magnetising Current (%)		
4.4	Load Loss on Nominal tap position with nominal primary voltage applied (Watts)		
4.5	Impedance Voltage on Nominal tap position and Nominal Voltage (%)		
4.6	Reactance Voltage on Nominal tap position and Nominal Voltage (%)		
4.7	Resistance Voltage on Nominal tap position and Nominal Voltage (%)		
4.8	Zero Phase Sequence Impedance (Ohm/Phase)		
4.9	Regulation		
4.9.1	• At Full Load and 1.0 PF		
4.9.2	• At Full Load and 0.8 PF		
4.10	Efficiency at Full Load and 1.0 PF		
4.11	Maximum Winding Temperature Rise (°C)		
4.12	Maximum Top Oil Temperature Rise (°C)		
4.13	Noise Level dB(A)		
4.14	Maximum Symmetrical Short Circuit Current withstand for 2 seconds (Three and Two phase) (A)		
4.15	Maximum Earth Fault Current withstand for 2 seconds (Single Phase) (A)		
4.16	Lightning Impulse Withstand Voltage (kVp)		
4.17	Power Frequency Voltage Withstand (kV RMS)		
4.18	Life Cycle Cost 'K'		

PUBLIC

	SPECIFICATION ENQUIRY	HPC-8DJ-03-0004-2013
	VENDOR'S NAME	
	DATE	

TECHNICAL SCHEDULES A & B

ITEM 3: Three Phase Aerial Transformers

VOLTAGE (kV)	11/6.38	22	33	11/6.38	22	33	11/6.38	22	33		
ITEM	3.1	3.2	3.3	3.4	3.5	3.6	3.7	3.8	3.9		
SIZE (kVA)	100	100	100	200	200	200	315	315	315		

SCHEDULE A: Horizon Power's specific requirements

SCHEDULE B: Particulars of equipment to be supplied (to be completed by Vendor)

No	Clause	Description	Schedule A	Schedule B
		Distribution Standard Buyers Guide drawing	HPA-SD-E-0004-01	xxxx
1		General		
1.1		Manufacturer		
1.2		Brand / Catalogue No. / Model		
1.3		Country of Manufacture		
2		Dimensions		
2.1		Width (mm)		
2.2		Height (mm)		
2.3		Depth (mm)		
2.4		Mass (kg)		
3		Particulars of Plant		
3.1		Rated Primary Voltage (kV)		
3.2		Rated Power (kVA)		
3.3		Number of Tap Positions		
3.4		Tap Step Size (%)		
3.5		Vector Group		
3.6		Quantity of oil (Litres)		
3.7		MV Bushings		
3.7.1		Manufacturer		
3.7.2		Type		
3.7.3		Creepage Length (mm)		
3.7.4		Lightning Impulse Withstand Voltage (kVp)		
3.8		LV Bushings		
3.8.1		Manufacturer		
3.8.2		Type		
3.8.3		Lightning Impulse Withstand Voltage (kVp)		
3.9		Minimum Clearance between external live metal parts		
3.9.1		Phase to Phase (MV) (mm)		
3.9.2		Phase to Earth (MV) (mm)		
3.9.3		Phase to Phase (LV) (mm)		
3.9.4		Phase to Earth (LV) (mm)		

PUBLIC

4	Guaranteed Performance		
4.1	No load Voltage ratio corresponding to Nominal Tap Position		
4.2	No load Loss (Watts)		
4.3	Magnetising Current (%)		
4.4	Load Loss on Nominal tap position with nominal primary voltage applied (Watts)		
4.5	Impedance Voltage on Nominal tap position and Nominal Voltage (%)		
4.6	Reactance Voltage on Nominal tap position and Nominal Voltage (%)		
4.7	Resistance Voltage on Nominal tap position and Nominal Voltage (%)		
4.8	Zero Phase Sequence Impedance (Ohm/Phase)		
4.9	Regulation		
4.9.1	• At Full Load and 1.0 PF		
4.9.2	• At Full Load and 0.8 PF		
4.10	Efficiency at Full Load and 1.0 PF		
4.11	Maximum Winding Temperature Rise (°C)		
4.12	Maximum Top Oil Temperature Rise (°C)		
4.13	Noise Level dB(A)		
4.14	Maximum Symmetrical Short Circuit Current withstand for 2 seconds (Three and Two phase) (A)		
4.15	Maximum Earth Fault Current withstand for 2 seconds (Single Phase) (A)		
4.16	Lightning Impulse Withstand Voltage (kVp)		
4.17	Power Frequency Voltage Withstand (kV RMS)		
4.18	Life Cycle Cost 'K'		

PUBLIC

	SPECIFICATION ENQUIRY	HPC-8DJ-03-0004-2013
	VENDOR'S NAME	
	DATE	

TECHNICAL SCHEDULES A & B

ITEM 4: Isolation Aerial Transformers

VOLTAGE (kV)	22/12.7	33/19.1	22/12.7	33/19.1	22/12.7	33/19.1		
ITEM	4.1	4.2	4.3	4.4	4.5	4.6		
SIZE (kVA)	63	63	200	200	315	315		

SCHEDULE A: Horizon Power's specific requirements

SCHEDULE B: Particulars of equipment to be supplied (to be completed by Vendor)

No	Clause	Description	Schedule A	Schedule B
		Distribution Standard Buyers Guide drawing	HPA-SD-E-00005-01	xxxx
1		General		
1.1		Manufacturer		
1.2		Brand / Catalogue No. / Model		
1.3		Country of Manufacture		
2		Dimensions		
2.1		Width (mm)		
2.2		Height (mm)		
2.3		Depth (mm)		
2.4		Mass (kg)		
3		Particulars of Plant		
3.1		Rated Primary Voltage (kV)		
3.2		Rated Power (kVA)		
3.3		Number of Tap Positions		
3.4		Tap Step Size (%)		
3.5		Vector Group		
3.6		Quantity of oil (Litres)		
3.7		MV Bushings		
3.7.1		Manufacturer		
3.7.2		Type		
3.7.3		Creepage Length (mm)		
3.7.4		Lightning Impulse Withstand Voltage (kVp)		
3.8		Minimum Clearance between external live metal parts		
3.8.1		Phase to Phase (MV) (mm)		
3.8.4		Phase to Earth (MV) (mm)		
4		Guaranteed Performance		
4.1		No load Voltage ratio corresponding to Nominal Tap Position		
4.2		No load Loss (Watts)		
4.3		Magnetising Current (%)		
4.4		Load Loss on Nominal tap position with nominal primary voltage applied (Watts)		
4.5		Impedance Voltage on Nominal tap position and Nominal Voltage (%)		

PUBLIC

4.6	Reactance Voltage on Nominal tap position and Nominal Voltage (%)		
4.7	Resistance Voltage on Nominal tap position and Nominal Voltage (%)		
4.8	Zero Phase Sequence Impedance (Ohm/Phase)		
4.9	Regulation		
4.9.1	• At Full Load and 1.0 PF		
4.9.2	• At Full Load and 0.8 PF		
4.10	Efficiency at Full Load and 1.0 PF		
4.11	Maximum Winding Temperature Rise (°C)		
4.12	Maximum Top Oil Temperature Rise (°C)		
4.13	Noise Level dB(A)		
4.14	Maximum Symmetrical Short Circuit Current withstand for 2 seconds (Three and Two phase) (A)		
4.15	Maximum Earth Fault Current withstand for 2 seconds (Single Phase) (A)		
4.16	Lightning Impulse Withstand Voltage (kVp)		
4.17	Power Frequency Voltage Withstand (kV RMS)		
4.18	Life Cycle Cost 'K'		

PUBLIC

	SPECIFICATION ENQUIRY	HPC-8DJ-03-0004-2013
	VENDOR'S NAME	
	DATE	

TECHNICAL SCHEDULES A & B

ITEM 5: Modular Packaged Substations (MPS)

VOLTAGE (kV)	11/6.38	22	33	11/6.38	22	33	11/6.38	22	33	
ITEM	5.1	5.2	5.3	5.4	5.5	5.6	5.7	5.8	5.9	
SIZE (kVA)	160	160	160	315	315	315	630	630	630	

SCHEDULE A: Horizon Power's specific requirements

SCHEDULE B: Particulars of equipment to be supplied (to be completed by Vendor)

No	Clause	Description	Schedule A	Schedule B
		Distribution Standard Buyers Guide drawing	HPA-SD-E-01002-01	xxxx
1		General		
1.1		Manufacturer		
1.2		Brand / Catalogue No. / Model		
1.3		Country of Manufacture		
2		Dimensions		
2.1		Width (mm)		
2.2		Height (mm)		
2.3		Depth (mm)		
2.4		Mass (kg)		
2.5		Mass Transformer only (kg)		
3		Particulars of Plant		
3.1		Rated Primary Voltage (kV)		
3.2		Rated Power (kVA)		
3.3		Number of Tap Positions		
3.4		Tap Step Size (%)		
3.5		Vector Group		
3.6		Quantity of oil (Litres)		
3.7		MV Bushings		
3.7.1		Manufacturer		
3.7.2		Type		
3.7.3		Lightning Impulse Withstand Voltage (kVp)		
3.8		LV Bushings		
3.8.1		Manufacturer		
3.8.2		Type		
3.8.3		Lightning Impulse Withstand Voltage (kVp)		
3.9		Minimum Clearance between external live metal parts		
3.9.1		Phase to Phase (MV) (mm)		
3.9.2		Phase to Earth (MV) (mm)		
3.9.3		Phase to Phase (LV) (mm)		
3.9.4		Phase to Earth (LV) (mm)		

PUBLIC

4		Guaranteed Performance		
4.1		No load Voltage ratio corresponding to Nominal Tap Position		
4.2		No load Loss (Watts)		
4.3		Magnetising Current (%)		
4.4		Load Loss on Nominal tap position with nominal primary voltage applied (Watts)		
4.5		Impedance Voltage on Nominal tap position and Nominal Voltage (%)		
4.6		Reactance Voltage on Nominal tap position and Nominal Voltage (%)		
4.7		Resistance Voltage on Nominal tap position and Nominal Voltage (%)		
4.8		Zero Phase Sequence Impedance (Ohm/Phase)		
4.9		Regulation		
4.9.1		• At Full Load and 1.0 PF		
4.9.2		• At Full Load and 0.8 PF		
4.10		Efficiency at Full Load and 1.0 PF		
4.11		Maximum Winding Temperature Rise (°C)		
4.12		Maximum Top Oil Temperature Rise (°C)		
4.13		Noise Level dB(A)		
4.14		Maximum Symmetrical Short Circuit Current withstand for 2 seconds (Three and Two phase) (A)		
4.15		Maximum Earth Fault Current withstand for 2 seconds (Single Phase) (A)		
4.16		Lightning Impulse Withstand Voltage (kVp)		
4.17		Power Frequency Voltage Withstand (kV RMS)		
5		Particulars of Plant LV Switchgear		
5.1		Nominal Voltage (V)		
5.2		Highest Voltage (V)		
5.3		Quantity of Switch Units per Substation		
5.3.1		• Fuse Links		
5.3.2		• Isolating Links		
5.4		Maximum Cable Size which can be Connected (mm ²)		
5.4.1		• Aluminium		
5.4.2		• Copper		
5.5		Maximum Lug size used (mm ²)		
5.5.1		• Aluminium		
5.5.2		• Copper		
6		Guaranteed Performance of LV Switchgear		
6.1		Rated Normal Current (A)		
6.1.1		• With Fuse Links Installed		
6.1.2		• With Isolating Links Installed		
6.2		Rated Withstand Current (kA)		
6.2.1		• With Fuse Links Installed		
6.2.2		• With Isolating Links Installed		
6.3		Rated Short Time Current (kA/1 sec)		
6.3.1		• With Fuse Links Installed		

PUBLIC

6.3.2		<ul style="list-style-type: none"> With Isolating Links Installed 		
6.4		Power Frequency Voltage Withstand (kV rms)		
6.5		Insulation Level between Terminals fitted with maximum sized Cable Lugs (kV)		
6.6		Number of Mechanical Operations before replacement required		
6.6.1		<ul style="list-style-type: none"> With Fuse Links Installed 		
6.6.2		<ul style="list-style-type: none"> With Isolating Links Installed 		
6.7		Number of Load Break Operations before replacement required		
6.7.1		<ul style="list-style-type: none"> With Fuse Links Installed 		
6.7.2		<ul style="list-style-type: none"> With Isolating Links Installed 		
6.8		Watts Dissipation Permissible for LV Switch Fuse units (W)		
6.9		Enclosure Degree of Protection (IP rating)		
6.10		Life Cycle Cost 'K'		

PUBLIC

	SPECIFICATION ENQUIRY	HPC-8DJ-03-0004-2013
	VENDOR'S NAME	
	DATE	

TECHNICAL SCHEDULES A & B

ITEM 6: Non-Modular Packaged Substations (Non-MPS)

VOLTAGE (kV)	11/6.38	22	33	11/6.38	22	33				
ITEM	6.1	6.2	6.3	6.4	6.5	6.6				
SIZE (kVA)	160	160	160	315	315	315				
VOLTAGE (kV)	11/6.38	22	33	11/6.38	22	33				
ITEM	6.7	6.8	6.9	6.10	6.11	6.12				
SIZE (kVA)	630	630	630	1000	1000	1000				

SCHEDULE A: Horizon Power's specific requirements

SCHEDULE B: Particulars of equipment to be supplied (to be completed by Vendor)

No	Clause	Description	Schedule A	Schedule B
		Distribution Standard Buyers Guide drawing	HPA-SD-E-01003-01 & 02	xxxx
1		General		
1.1		Manufacturer		
1.2		Brand / Catalogue No. / Model		
1.3		Country of Manufacture		
2		Dimensions		
2.1		Width (mm)		
2.2		Height (mm)		
2.3		Depth (mm)		
2.4		Mass (kg)		
3		Particulars of Plant		
3.1		Rated Primary Voltage (kV)		
3.2		Rated Power (kVA)		
3.3		Number of Tap Positions		
3.4		Tap Step Size (%)		
3.5		Vector Group		
3.6		Quantity of oil (Litres)		
3.7		MV Bushings		
3.7.1		Manufacturer		
3.7.2		Type		
3.7.3		Lightning Impulse Withstand Voltage (kVp)		
3.8		LV Bushings		
3.8.1		Manufacturer		
3.8.2		Type		
3.8.3		Lightning Impulse Withstand Voltage (kVp)		

PUBLIC

3.9		Minimum Clearance between external live metal parts		
3.9.1		Phase to Phase (MV) (mm)		
3.9.2		Phase to Earth (MV) (mm)		
3.9.3		Phase to Phase (LV) (mm)		
3.9.4		Phase to Earth (LV) (mm)		
4		Guaranteed Performance		
4.1		No load Voltage ratio corresponding to Nominal Tap Position		
4.2		No load Loss (Watts)		
4.3		Magnetising Current (%)		
4.4		Load Loss on Nominal tap position with nominal primary voltage applied (Watts)		
4.5		Impedance Voltage on Nominal tap position and Nominal Voltage (%)		
4.6		Reactance Voltage on Nominal tap position and Nominal Voltage (%)		
4.7		Resistance Voltage on Nominal tap position and Nominal Voltage (%)		
4.8		Zero Phase Sequence Impedance (Ohm/Phase)		
4.9		Regulation		
4.9.1		• At Full Load and 1.0 PF		
4.9.2		• At Full Load and 0.8 PF		
4.10		Efficiency at Full Load and 1.0 PF		
4.11		Maximum Winding Temperature Rise (°C)		
4.12		Maximum Top Oil Temperature Rise (°C)		
4.13		Noise Level dB(A)		
4.14		Maximum Symmetrical Short Circuit Current withstand for 2 seconds (Three and Two phase) (A)		
4.15		Maximum Earth Fault Current withstand for 2 seconds (Single Phase) (A)		
4.16		Lightning Impulse Withstand Voltage (kVp)		
4.17		Power Frequency Voltage Withstand (kV RMS)		
5		Particulars of Plant LV Switchgear		
5.1		Nominal Voltage (V)		
5.2		Highest Voltage (V)		
5.3		Type of Protection Device		
5.4		Maximum Cable Size which can be Connected (mm ²)		
5.4.1		• Aluminium		
5.4.2		• Copper		
5.5		Maximum Lug size used (mm ²)		
5.5.1		• Aluminium		
5.5.2		• Copper		
6		Guaranteed Performance of LV Switchgear		
6.1		Rated Normal Current (A)		
6.2		Rated Withstand Current (kA)		
6.3		Rated Short Time Current (kA/1 sec)		

PUBLIC

6.4		Power Frequency Voltage Withstand (kV rms)		
6.5		Insulation Level between Terminals fitted with maximum sized Cable Lugs (kV)		
6.6		Number of Mechanical Operations before replacement required		
6.7		Number of Load Break Operations before replacement required		
6.8		Watts Dissipation Permissible for LV Switch Fuse units (W)		
6.9		Enclosure Degree of Protection (IP rating)		
6.10		Life Cycle Cost 'K'		

APPENDIX D SCHEDULE C: COMPLIANCE DOCUMENT

The Vendor must indicate below whether this offer is fully compliant with the nominated clause in this Specification. A YES must ONLY be indicated if the offer is 100% compliant with the relevant Clause. If NO is indicated and supporting documents are submitted, then mark the ATT box with the attachment number

CLAUSE NUMBER		YES	NO	ATT.
3	REQUIREMENTS			
3.1	Power System Particulars			
3.1.1	<i>Rated Voltages</i>	<input type="checkbox"/>	<input type="checkbox"/>	<input type="checkbox"/>
3.1.2	<i>Fault Rating</i>	<input type="checkbox"/>	<input type="checkbox"/>	<input type="checkbox"/>
3.1.3	<i>Nominal System Frequency</i>	<input type="checkbox"/>	<input type="checkbox"/>	<input type="checkbox"/>
3.1.4	<i>System Insulation Levels</i>	<input type="checkbox"/>	<input type="checkbox"/>	<input type="checkbox"/>
3.1.5	<i>Pollution Performance</i>	<input type="checkbox"/>	<input type="checkbox"/>	<input type="checkbox"/>
3.2	Service Conditions			
3.2.1	<i>Environmental Conditions</i>	<input type="checkbox"/>	<input type="checkbox"/>	<input type="checkbox"/>
3.2.2	<i>Operating Conditions</i>			
3.2.2.1	<i>Cyclic Loading</i>	<input type="checkbox"/>	<input type="checkbox"/>	<input type="checkbox"/>
3.2.2.2	<i>Cooling Criteria</i>	<input type="checkbox"/>	<input type="checkbox"/>	<input type="checkbox"/>
3.2.2.3	<i>Seismic Disturbances</i>	<input type="checkbox"/>	<input type="checkbox"/>	<input type="checkbox"/>
3.2.2.4	<i>Wind Loads</i>	<input type="checkbox"/>	<input type="checkbox"/>	<input type="checkbox"/>
3.2.2.5	<i>Noise</i>	<input type="checkbox"/>	<input type="checkbox"/>	<input type="checkbox"/>
3.2.3	<i>Service Conditions</i>	<input type="checkbox"/>	<input type="checkbox"/>	<input type="checkbox"/>
4	TRANSFORMER DESIGN AND CONSTRUCTION			
4.1	General	<input type="checkbox"/>	<input type="checkbox"/>	<input type="checkbox"/>
4.2	High Efficiency Low Loss Design	<input type="checkbox"/>	<input type="checkbox"/>	<input type="checkbox"/>
4.3	Loading	<input type="checkbox"/>	<input type="checkbox"/>	<input type="checkbox"/>
4.4	Radiators	<input type="checkbox"/>	<input type="checkbox"/>	<input type="checkbox"/>
4.5	Tanks and Lids	<input type="checkbox"/>	<input type="checkbox"/>	<input type="checkbox"/>
4.6	Joints and Gaskets	<input type="checkbox"/>	<input type="checkbox"/>	<input type="checkbox"/>
4.7	Core	<input type="checkbox"/>	<input type="checkbox"/>	<input type="checkbox"/>
4.8	Windings	<input type="checkbox"/>	<input type="checkbox"/>	<input type="checkbox"/>
4.8.1	<i>Single Phase Transformers</i>	<input type="checkbox"/>	<input type="checkbox"/>	<input type="checkbox"/>
4.8.2	<i>Three Phase Transformers</i>	<input type="checkbox"/>	<input type="checkbox"/>	<input type="checkbox"/>
4.8.3	<i>Single Wire Earth Wire Return Distribution Transformers</i>	<input type="checkbox"/>	<input type="checkbox"/>	<input type="checkbox"/>
4.8.4	<i>Isolation Distribution Transformers</i>	<input type="checkbox"/>	<input type="checkbox"/>	<input type="checkbox"/>

PUBLIC

CLAUSE NUMBER		YES	NO	ATT.
4.9	Tappings	<input type="checkbox"/>	<input type="checkbox"/>	<input type="checkbox"/>
4.10	Cooling	<input type="checkbox"/>	<input type="checkbox"/>	<input type="checkbox"/>
4.11	Insulating Oil	<input type="checkbox"/>	<input type="checkbox"/>	<input type="checkbox"/>
4.12	Bushings and Terminals			
4.12.1	<i>General</i>	<input type="checkbox"/>	<input type="checkbox"/>	<input type="checkbox"/>
4.12.2	<i>MV Bushings</i>	<input type="checkbox"/>	<input type="checkbox"/>	<input type="checkbox"/>
4.12.3	<i>LV Bushings</i>	<input type="checkbox"/>	<input type="checkbox"/>	<input type="checkbox"/>
4.13	Painting	<input type="checkbox"/>	<input type="checkbox"/>	<input type="checkbox"/>
4.13.1	<i>Aerial Transformers</i>	<input type="checkbox"/>	<input type="checkbox"/>	<input type="checkbox"/>
4.13.2	<i>Ground-mounted Transformers</i>	<input type="checkbox"/>	<input type="checkbox"/>	<input type="checkbox"/>
4.14	Transformer Fittings			
4.14.1	<i>Rating Plates and Terminal Markings</i>	<input type="checkbox"/>	<input type="checkbox"/>	<input type="checkbox"/>
4.14.2	<i>Lifting and Transport Facilities</i>	<input type="checkbox"/>	<input type="checkbox"/>	<input type="checkbox"/>
4.14.3	<i>Oil Level Indicator</i>	<input type="checkbox"/>	<input type="checkbox"/>	<input type="checkbox"/>
4.14.4	<i>Earthing Bracket</i>	<input type="checkbox"/>	<input type="checkbox"/>	<input type="checkbox"/>
4.14.5	<i>Tank Markings</i>	<input type="checkbox"/>	<input type="checkbox"/>	<input type="checkbox"/>
4.15	Performance Criteria			
4.15.1	<i>Minimum Power Efficiency (MEPS)</i>	<input type="checkbox"/>	<input type="checkbox"/>	<input type="checkbox"/>
4.15.2	<i>Guaranteed Transformer Losses</i>	<input type="checkbox"/>	<input type="checkbox"/>	<input type="checkbox"/>
4.15.3	<i>Allowable Tolerance for Transformer Losses</i>	<input type="checkbox"/>	<input type="checkbox"/>	<input type="checkbox"/>
4.15.4	<i>Transformer Impedances</i>	<input type="checkbox"/>	<input type="checkbox"/>	<input type="checkbox"/>
5	AERIAL TRANSFORMERS			
5.1	General	<input type="checkbox"/>	<input type="checkbox"/>	<input type="checkbox"/>
5.1.1	<i>Transformer Mounting Brackets</i>	<input type="checkbox"/>	<input type="checkbox"/>	<input type="checkbox"/>
5.1.2	<i>Surge Arrester Brackets</i>	<input type="checkbox"/>	<input type="checkbox"/>	<input type="checkbox"/>
5.1.3	<i>LV Winding Bushings</i>	<input type="checkbox"/>	<input type="checkbox"/>	<input type="checkbox"/>
5.1.4	<i>MV Winding Bushing</i>	<input type="checkbox"/>	<input type="checkbox"/>	<input type="checkbox"/>
5.1.5	<i>Earthing</i>	<input type="checkbox"/>	<input type="checkbox"/>	<input type="checkbox"/>
5.2	Single Phase Transformers			
5.2.1	<i>General</i>	<input type="checkbox"/>	<input type="checkbox"/>	<input type="checkbox"/>
5.2.2	<i>Terminal Arrangement for MV Winding</i>	<input type="checkbox"/>	<input type="checkbox"/>	<input type="checkbox"/>
5.2.3	<i>Additional Requirements</i>	<input type="checkbox"/>	<input type="checkbox"/>	<input type="checkbox"/>
5.3	Three Phase Transformers			
5.3.1	<i>Additional Requirements</i>	<input type="checkbox"/>	<input type="checkbox"/>	<input type="checkbox"/>

PUBLIC

CLAUSE NUMBER		YES	NO	ATT.
5.4	Isolation Transformers			
5.4.1	<i>General</i>	<input type="checkbox"/>	<input type="checkbox"/>	<input type="checkbox"/>
5.4.2	<i>Additional Requirements</i>	<input type="checkbox"/>	<input type="checkbox"/>	<input type="checkbox"/>
6	GROUND-MOUNTED TRANSFORMERS			
6.1	Supply of Packaged Substations	<input type="checkbox"/>	<input type="checkbox"/>	<input type="checkbox"/>
6.2	General for Packaged Substations			
6.2.1	<i>Physical</i>	<input type="checkbox"/>	<input type="checkbox"/>	<input type="checkbox"/>
6.2.2	<i>MV/LV Cubicle</i>			
6.2.2.1	<i>General</i>	<input type="checkbox"/>	<input type="checkbox"/>	<input type="checkbox"/>
6.2.2.2	<i>Doors</i>	<input type="checkbox"/>	<input type="checkbox"/>	<input type="checkbox"/>
6.2.2.3	<i>Earthing</i>	<input type="checkbox"/>	<input type="checkbox"/>	<input type="checkbox"/>
6.2.3	<i>MV Winding Bushing</i>	<input type="checkbox"/>	<input type="checkbox"/>	<input type="checkbox"/>
6.2.4	<i>Base Frame</i>	<input type="checkbox"/>	<input type="checkbox"/>	<input type="checkbox"/>
6.3	Modular Packaged Substations (MPS)			
6.3.1	<i>General</i>	<input type="checkbox"/>	<input type="checkbox"/>	<input type="checkbox"/>
6.3.2	<i>Physical</i>	<input type="checkbox"/>	<input type="checkbox"/>	<input type="checkbox"/>
6.3.3	<i>MV/LV Cubicle</i>			
6.3.3.1	<i>General</i>	<input type="checkbox"/>	<input type="checkbox"/>	<input type="checkbox"/>
6.3.3.2	<i>Doors</i>	<input type="checkbox"/>	<input type="checkbox"/>	<input type="checkbox"/>
6.3.4	<i>LV Winding Bushings</i>	<input type="checkbox"/>	<input type="checkbox"/>	<input type="checkbox"/>
6.3.5	<i>Low Voltage Switchgear</i>			
6.3.5.1	<i>General</i>	<input type="checkbox"/>	<input type="checkbox"/>	<input type="checkbox"/>
6.3.5.2	LV Switchgear Arrangement	<input type="checkbox"/>	<input type="checkbox"/>	<input type="checkbox"/>
6.3.5.3	Fuse Switch Disconnectors	<input type="checkbox"/>	<input type="checkbox"/>	<input type="checkbox"/>
6.3.5.4	<i>Cable and Terminations</i>	<input type="checkbox"/>	<input type="checkbox"/>	<input type="checkbox"/>
6.3.6	<i>Other Requirements for MPS Transformers</i>	<input type="checkbox"/>	<input type="checkbox"/>	<input type="checkbox"/>
6.4	Non-Modular Packaged Substations (Non-MPS)			
6.4.1	<i>General</i>	<input type="checkbox"/>	<input type="checkbox"/>	<input type="checkbox"/>
6.4.2	<i>Physical</i>	<input type="checkbox"/>	<input type="checkbox"/>	<input type="checkbox"/>
6.4.3	<i>MV/LV Cubicle Details</i>			
6.4.3.1	<i>General</i>	<input type="checkbox"/>	<input type="checkbox"/>	<input type="checkbox"/>
6.4.3.2	<i>Doors</i>	<input type="checkbox"/>	<input type="checkbox"/>	<input type="checkbox"/>
6.4.4	<i>LV Winding Bushings</i>	<input type="checkbox"/>	<input type="checkbox"/>	<input type="checkbox"/>
6.4.5	<i>Low Voltage Fuse/MCCB</i>	<input type="checkbox"/>	<input type="checkbox"/>	<input type="checkbox"/>
6.4.5.1	<i>General</i>	<input type="checkbox"/>	<input type="checkbox"/>	<input type="checkbox"/>

PUBLIC

CLAUSE NUMBER		YES	NO	ATT.
6.4.5.2	LV Fuse Switch Disconnecter	<input type="checkbox"/>	<input type="checkbox"/>	<input type="checkbox"/>
6.4.5.3	Moulded Case Circuit Breaker (MCCB)	<input type="checkbox"/>	<input type="checkbox"/>	<input type="checkbox"/>
6.4.5.4	<i>Cable and Terminations</i>	<input type="checkbox"/>	<input type="checkbox"/>	<input type="checkbox"/>
6.4.6	<i>Other Requirements for Non-MPS Transformers</i>	<input type="checkbox"/>	<input type="checkbox"/>	<input type="checkbox"/>
7.	STORAGE	<input type="checkbox"/>	<input type="checkbox"/>	<input type="checkbox"/>
8.	RELIABILITY	<input type="checkbox"/>	<input type="checkbox"/>	<input type="checkbox"/>
9.	SAFETY	<input type="checkbox"/>	<input type="checkbox"/>	<input type="checkbox"/>
10.	ENVIRONMENTAL CONDITIONS	<input type="checkbox"/>	<input type="checkbox"/>	<input type="checkbox"/>
11.	TESTS			
11.1	Test Requirements	<input type="checkbox"/>	<input type="checkbox"/>	<input type="checkbox"/>
11.1.1	<i>Type Tests</i>	<input type="checkbox"/>	<input type="checkbox"/>	<input type="checkbox"/>
11.1.2	<i>Routine and Sample Tests</i>	<input type="checkbox"/>	<input type="checkbox"/>	<input type="checkbox"/>
11.1.3	<i>Special Tests</i>	<input type="checkbox"/>	<input type="checkbox"/>	<input type="checkbox"/>
11.1.3	<i>Pressure Tests</i>	<input type="checkbox"/>	<input type="checkbox"/>	<input type="checkbox"/>
11.1.3	<i>Witness Tests</i>	<input type="checkbox"/>	<input type="checkbox"/>	<input type="checkbox"/>
12.	DOCUMENTATION AND SAMPLES	<input type="checkbox"/>	<input type="checkbox"/>	<input type="checkbox"/>
12.1	Type Test Certificates/Reports	<input type="checkbox"/>	<input type="checkbox"/>	<input type="checkbox"/>
12.2	Samples			
12.2.1	<i>Tests Samples</i>	<input type="checkbox"/>	<input type="checkbox"/>	<input type="checkbox"/>
12.2.2	<i>Display Samples</i>	<input type="checkbox"/>	<input type="checkbox"/>	<input type="checkbox"/>
13.	PACKAGING REQUIREMENTS	<input type="checkbox"/>	<input type="checkbox"/>	<input type="checkbox"/>

PUBLIC

APPENDIX F SCHEDULE E: TRANSFORMER DESCRIPTION

ITEM	DESCRIPTION	DISTRIBUTION STANDARD DRAWING
1	Single Phase Aerial Transformers	
1.1	Short Description: TRANSFORMER, POWER; 10 kVA 6-11 kV/240-480 V; 1 PH; 2 BUSHING; AERIAL CONN Technical Description: TRANSFORMER, POWER; 10 kVA 6-11 kV/240-480 V; 1 PH; 50 Hz; SP; 2 BUSHING; AERIAL CONN	HPA-SD-E-00002-Sht 01
1.2	Short Description: TRANSFORMER, POWER; 10 kVA 12.7 kV/240-480 V; 1 PH; AERIAL CONN Technical Description: TRANSFORMER, POWER; 10 kVA 12.7 kV/240-480 V; 1 PH; 50 Hz; SWEWR; AERIAL CONN	HPA-SD-E-00001-Sht 01
1.3	Short Description: TRANSFORMER, POWER; 10 kVA 19.1 kV/240-480 V; 1 PH; AERIAL CONN Technical Description: TRANSFORMER, POWER; 10 kVA 19.1 kV/240-480 V; 1 PH; 50 Hz; SWEWR; AERIAL CONN	HPA-SD-E-00001-Sht 01
1.4	Short Description: TRANSFORMER, POWER; 10 kVA 22 kV/240-480 V; 1 PH; 2 BUSHING; AERIAL CONN Technical Description: TRANSFORMER, POWER; 10 kVA 22 kV/240-480 V; 1 PH; 50 Hz; SP; 2 BUSHING; AERIAL CONN	HPA-SD-E-00002-Sht 01
1.5	Short Description: TRANSFORMER, POWER; 25 kVA 12.7 kV/240-480 V; 1 PH; AERIAL CONN Technical Description: TRANSFORMER, POWER; 25 kVA 12.7 kV/240-480 V; 1 PH; 50 Hz; SWEWR; AERIAL CONN	HPA-SD-E-00001-Sht 01
1.6	Short Description: TRANSFORMER, POWER; 25 kVA 19.1 V/240-480 V; 1 PH; AERIAL CONN Technical Description: TRANSFORMER, POWER; 25 kVA 19.1 kV/240-480 V; 1 PH; 50 Hz; SWEWR; AERIAL CONN	HPA-SD-E-00001-Sht 01
1.7	Short Description: TRANSFORMER, POWER; 25 kVA 22 kV/240-480 V; 1 PH; 2 BUSHING; AERIAL CONN Technical Description: TRANSFORMER, POWER; 25 kVA 22 kV/240-480 V; 1 PH; 50 Hz; SP; 2 BUSHING; AERIAL CONN	HPA-SD-E-00002-Sht 01
1.8	Short Description: TRANSFORMER, POWER; 25 kVA 33 kV/240-480 V; 1 PH; 2 BUSHING; AERIAL CONN Technical Description: TRANSFORMER, POWER; 25 kVA 33 kV/240-480 V; 1 PH; 50 Hz; SP; 2 BUSHING; AERIAL CONN	HPA-SD-E-00002-Sht 01
2	Three Phase Aerial Transformers	
2.1	Short Description: TRANSFORMER, POWER; 25 kVA 6-11 kV/415 V; 3 PH; AERIAL CONN Technical Description: TRANSFORMER, POWER; 25 kVA 6-11 kV/415 V; 3 PH; 50 Hz; Dyn1; AERIAL CONN	HPA-SD-E-00003-Sht 01

PUBLIC

ITEM	DESCRIPTION	DISTRIBUTION STANDARD DRAWING
2.2	Short Description: TRANSFORMER, POWER; 25 kVA 22 kV/415 V; 3 PH; AERIAL CONN Technical Description: TRANSFORMER, POWER; 25 kVA 22 kV/415 V; 3 PH; 50 Hz; Dyn1; AERIAL CONN	HPA-SD-E-00003-Sht 01
2.3	Short Description: TRANSFORMER, POWER; 25 kVA 33 kV/415 V; 3 PH; AERIAL CONN Technical Description: TRANSFORMER, POWER; 25 kVA 33 kV/415 V; 3 PH; 50 Hz; Dyn1; AERIAL CONN	HPA-SD-E-00003-Sht 01
2.4	Short Description: TRANSFORMER, POWER; 63 kVA 6-11 kV/415 V; 3 PH; AERIAL CONN Technical Description: TRANSFORMER, POWER; 63 kVA 6-11 kV/415 V; 3 PH; 50 Hz; Dyn1; AERIAL CONN	HPA-SD-E-00003-Sht 01
2.5	Short Description: TRANSFORMER, POWER; 63 kVA 22 kV/415 V; 3 PH; AERIAL CONN Technical Description: TRANSFORMER, POWER; 63 kVA 22 kV/415 V; 3 PH; 50 Hz; Dyn1; AERIAL CONN	HPA-SD-E-00003-Sht 01
2.6	Short Description: TRANSFORMER, POWER; 63 kVA 33 kV/415 V; 3 PH; AERIAL CONN Technical Description: TRANSFORMER, POWER; 63 kVA 33 kV/415 V; 3 PH; 50 Hz; Dyn1; AERIAL CONN	HPA-SD-E-00003-Sht 01
3	Three Phase Aerial Transformers	
3.1	Short Description: TRANSFORMER, POWER; 100 kVA 6-11 kV/415 V; 3 PH; AERIAL CONN Technical Description: TRANSFORMER, POWER; 100 kVA 6-11 kV/415 V; 3 PH; 50 Hz; Dyn1; AERIAL CONN	HPA-SD-E-00004-Sht 01
3.2	Short Description: TRANSFORMER, POWER; 100 kVA 22 kV/415 V; 3 PH; AERIAL CONN Technical Description: TRANSFORMER, POWER; 100 kVA 22 kV/415 V; 3 PH; 50 Hz; Dyn1; AERIAL CONN	HPA-SD-E-00004-Sht 01
3.3	Short Description: TRANSFORMER, POWER; 100 kVA 33 kV/415 V; 3 PH; AERIAL CONN Technical Description: TRANSFORMER, POWER; 100 kVA 33 kV/415 V; 3 PH; 50 Hz; Dyn1; AERIAL CONN	HPA-SD-E-00004-Sht 01
3.4	Short Description: TRANSFORMER, POWER; 200 kVA 6-11 kV/415 V; 3 PH; AERIAL CONN Technical Description: TRANSFORMER, POWER; 200 kVA 6-11 kV/415 V; 3 PH; 50 Hz; Dyn1; AERIAL CONN	HPA-SD-E-00004-Sht 01

PUBLIC

ITEM	DESCRIPTION	DISTRIBUTION STANDARD DRAWING
3.5	Short Description: TRANSFORMER, POWER; 200 kVA 22 kV/415 V; 3 PH; AERIAL CONN Technical Description: TRANSFORMER, POWER; 200 kVA 22 kV/415 V; 3 PH; 50 Hz; Dyn1; AERIAL CONN	HPA-SD-E-00004-Sht 01
3.6	Short Description: TRANSFORMER, POWER; 200 kVA 33 kV/415 V; 3 PH; AERIAL CONN Technical Description: TRANSFORMER, POWER; 200 kVA 33 kV/415 V; 3 PH; 50 Hz; Dyn1; AERIAL CONN	HPA-SD-E-00004-Sht 01
3.7	Short Description: TRANSFORMER, POWER; 315 kVA 6-11 kV/415 V; 3 PH; AERIAL CONN Technical Description: TRANSFORMER, POWER; 315 kVA 6-11 kV/415 V; 3 PH; 50 Hz; Dyn1; AERIAL CONN	HPA-SD-E-00004-Sht 01
3.8	Short Description: TRANSFORMER, POWER; 315 kVA 22 kV/415 V; 3 PH; AERIAL CONN Technical Description: TRANSFORMER, POWER; 315 kVA 22 kV/415 V; 3 PH; 50 Hz; Dyn1; AERIAL CONN	HPA-SD-E-00004-Sht 01
3.9	Short Description: TRANSFORMER, POWER; 315 kVA 33 kV/415 V; 3 PH; AERIAL CONN Technical Description: TRANSFORMER, POWER; 315 kVA 33 kV/415 V; 3 PH; 50 Hz; Dyn1; AERIAL CONN	HPA-SD-E-00004-Sht 01
4	Isolation Aerial Transformers	
4.1	Short Description: TRANSFORMER, POWER; 63 kVA 22/12.7 kV; 1 PH; AERIAL CONN Technical Description: TRANSFORMER, POWER; 63 kVA 22/12.7 kV; 1 PH; 50 Hz; SP; 2 BUSHING; AERIAL CONN	HPA-SD-E-00005-Sht 01
4.2	Short Description: TRANSFORMER, POWER; 63 kVA 33/19.1 kV; 1 PH; AERIAL CONN Technical Description: TRANSFORMER, POWER; 63 kVA 33/19.1 kV; 1 PH; 50 Hz; SP; 2 BUSHING; AERIAL CONN	HPA-SD-E-00005-Sht 01
4.3	Short Description: TRANSFORMER, POWER; 200 kVA 22/12.7 kV; 1 PH; AERIAL CONN Technical Description: TRANSFORMER, POWER; 200 kVA 22/12.7 kV; 1 PH; 50 Hz; SP; 2 BUSHING; AERIAL CONN	HPA-SD-E-00005-Sht 01
4.4	Short Description: TRANSFORMER, POWER; 200 kVA 33/19.1 kV; 1 PH; AERIAL CONN Technical Description: TRANSFORMER, POWER; 200 kVA 33/19.1 kV; 1 PH; 50 Hz; SP; 2 BUSHING; AERIAL CONN	HPA-SD-E-00005-Sht 01

PUBLIC

ITEM	DESCRIPTION	DISTRIBUTION STANDARD DRAWING
4.5	Short Description: TRANSFORMER, POWER; 315 kVA 22/12.7 kV; 1 PH; AERIAL CONN Technical Description: TRANSFORMER, POWER; 315 kVA 22/12.7 kV; 1 PH; 50 Hz; SP; 2 BUSHING; AERIAL CONN	HPA-SD-E-00005-Sht 01
4.6	Short Description: TRANSFORMER, POWER; 315 kVA 33/19.1 kV; 1 PH; AERIAL CONN Technical Description: TRANSFORMER, POWER; 315 kVA 33/19.1 kV; 1 PH; 50 Hz; SP; 2 BUSHING; AERIAL CONN	HPA-SD-E-00005-Sht 01
5	Modular Packaged Substations (MPS)	
5.1	Short Description: TRANSFORMER, POWER; 160 kVA 6-11 kV/415 V; 3 PH; PAD MTG; MPS Technical Description: TRANSFORMER, POWER; 160 kVA 6-11 kV/415 V; 3 PH; 50 Hz; Dyn1; PAD MTG; MPS; W/ELBOW CONN	HPA-SD-E-01002-Sht 01
5.2	Short Description: TRANSFORMER, POWER; 160 kVA 22 kV/415 V; 3 PH; PAD MTG; MPS Technical Description: TRANSFORMER, POWER; 160 kVA 22 kV/415 V; 3 PH; 50 Hz; Dyn1; PAD MTG; MPS; W/ELBOW CONN	HPA-SD-E-01002-Sht 01
5.3	Short Description: TRANSFORMER, POWER; 160 kVA 33 kV/415 V; 3 PH; PAD MTG; MPS Technical Description: TRANSFORMER, POWER; 160 kVA 33 kV/415 V; 3 PH; 50 Hz; Dyn1; PAD MTG; MPS; W/ELBOW CONN	HPA-SD-E-01002-Sht 01
5.4	Short Description: TRANSFORMER, POWER; 315 kVA 6-11 kV/415 V; 3 PH; PAD MTG; MPS Technical Description: TRANSFORMER, POWER; 315 kVA 6-11 kV/415 V; 3 PH; 50 Hz; Dyn1; PAD MTG; MPS; W/ELBOW CONN	HPA-SD-E-01002-Sht 01
5.5	Short Description: TRANSFORMER, POWER; 315 kVA 22 kV/415 V; 3 PH; PAD MTG; MPS Technical Description: TRANSFORMER, POWER; 315 kVA 22 kV/415 V; 3 PH; 50 Hz; Dyn1; PAD MTG; MPS; W/ELBOW CONN	HPA-SD-E-01002-Sht 01
5.6	Short Description: TRANSFORMER, POWER; 315 kVA 33 kV/415 V; 3 PH; PAD MTG; MPS Technical Description: TRANSFORMER, POWER; 315 kVA 33 kV/415 V; 3 PH; 50 Hz; Dyn1; PAD MTG; MPS; W/ELBOW CONN	HPA-SD-E-01002-Sht 01
5.7	Short Description: TRANSFORMER, POWER; 630 kVA 6-11 kV/415 V; 3 PH; PAD MTG; MPS Technical Description: TRANSFORMER, POWER; 630 kVA 6-11 kV/415 V; 3 PH; 50 Hz; Dyn1; PAD MTG; MPS; W/ELBOW CONN	HPA-SD-E-01002-Sht 01

PUBLIC

ITEM	DESCRIPTION	DISTRIBUTION STANDARD DRAWING
5.8	Short Description: TRANSFORMER, POWER; 630 kVA 22 kV/415 V; 3 PH; PAD MTG; MPS Technical Description: TRANSFORMER, POWER; 630 kVA 22 kV/415 V; 3 PH; 50 Hz; Dyn1; PAD MTG; MPS; W/ELBOW CONN	HPA-SD-E-01002-Sht 01
5.9	Short Description: TRANSFORMER, POWER; 630 kVA 33 kV/415 V; 3 PH; PAD MTG; MPS Technical Description: TRANSFORMER, POWER; 630 kVA 33 kV/415 V; 3 PH; 50 Hz; Dyn1; PAD MTG; MPS; W/ELBOW CONN	HPA-SD-E-01002-Sht 01
6	Non-Modular Packaged Substations (Non-MPS)	
6.1	Short Description: TRANSFORMER, POWER; 160 kVA 6-11 kV/415 V; 3 PH; PAD MTG; NON-MPS Technical Description: TRANSFORMER, POWER; 160 kVA 6-11 kV/415 V; 3 PH; 50 Hz; Dyn1; PAD MTG; NON-MPS; W/ELBOW CONN	HPA-SD-E-01003-Sht 01
6.2	Short Description: TRANSFORMER, POWER; 160 kVA 22 kV/415 V; 3 PH; PAD MTG; NON-MPS Technical Description: TRANSFORMER, POWER; 160 kVA 22 kV/415 V; 3 PH; 50 Hz; Dyn1; PAD MTG; NON-MPS; W/ELBOW CONN	HPA-SD-E-01003-Sht 01
6.3	Short Description: TRANSFORMER, POWER; 160 kVA 33 kV/415 V; 3 PH; PAD MTG; NON-MPS Technical Description: TRANSFORMER, POWER; 160 kVA 33 kV/415 V; 3 PH; 50 Hz; Dyn1; PAD MTG; NON-MPS; W/ELBOW CONN	HPA-SD-E-01003-Sht 01
6.4	Short Description: TRANSFORMER, POWER; 315 kVA 6-11 kV/415 V; 3 PH; PAD MTG; NON-MPS Technical Description: TRANSFORMER, POWER; 315 kVA 6-11 kV/415 V; 3 PH; 50 Hz; Dyn1; PAD MTG; NON-MPS; W/ELBOW CONN	HPA-SD-E-01003-Sht 01
6.5	Short Description: TRANSFORMER, POWER; 315 kVA 22 kV/415 V; 3 PH; PAD MTG; NON-MPS Technical Description: TRANSFORMER, POWER; 315 kVA 22 kV/415 V; 3 PH; 50 Hz; Dyn1; PAD MTG; NON-MPS; W/ELBOW CONN	HPA-SD-E-01003-Sht 01
6.6	Short Description: TRANSFORMER, POWER; 315 kVA 33 kV/415 V; 3 PH; PAD MTG; NON-MPS Technical Description: TRANSFORMER, POWER; 315 kVA 33 kV/415 V; 3 PH; 50 Hz; Dyn1; PAD MTG; NON-MPS; W/ELBOW CONN	HPA-SD-E-01003-Sht 01
6.7	Short Description: TRANSFORMER, POWER; 630 kVA 6-11 kV/415 V; 3 PH; PAD MTG; NON-MPS Technical Description: TRANSFORMER, POWER; 630 kVA 6-11 kV/415 V; 3 PH; 50 Hz; Dyn1; PAD MTG; NON-MPS; W/ELBOW CONN	HPA-SD-E-01003-Sht 01

PUBLIC

ITEM	DESCRIPTION	DISTRIBUTION STANDARD DRAWING
6.8	Short Description: TRANSFORMER, POWER; 630 kVA 22 kV/415 V; 3 PH; PAD MTG; NON-MPS Technical Description: TRANSFORMER, POWER; 630 kVA 22 kV/415 V; 3 PH; 50 Hz; Dyn1; PAD MTG; NON-MPS; W/ELBOW CONN	HPA-SD-E-01003-Sht 01
6.9	Short Description: TRANSFORMER, POWER; 630 kVA 33 kV/415 V; 3 PH; PAD MTG; NON-MPS Technical Description: TRANSFORMER, POWER; 630 kVA 33 kV/415 V; 3 PH; 50 Hz; Dyn1; PAD MTG; NON-MPS; W/ELBOW CONN	HPA-SD-E-01003-Sht 01
6.10	Short Description: TRANSFORMER, POWER; 1000 kVA 6-11 kV/415 V; 3 PH; PAD MTG; NON-MPS Technical Description: TRANSFORMER, POWER; 1000 kVA 6-11 kV/415 V; 3 PH; 50 Hz; Dyn1; PAD MTG; NON-MPS; W/ELBOW CONN	HPA-SD-E-01003-Sht 01
6.11	Short Description: TRANSFORMER, POWER; 1000 kVA 22 kV/415 V; 3 PH; PAD MTG; NON-MPS Technical Description: TRANSFORMER, POWER; 1000 kVA 22 kV/415 V; 3 PH; 50 Hz; Dyn1; PAD MTG; NON-MPS; W/ELBOW CONN	HPA-SD-E-01003-Sht 01
6.12	Short Description: TRANSFORMER, POWER; 1000 kVA 33 kV/415 V; 3 PH; PAD MTG; NON-MPS Technical Description: TRANSFORMER, POWER; 1000 kVA 33 kV/415 V; 3 PH; 50 Hz; Dyn1; PAD MTG; NON-MPS; W/ELBOW CONN	HPA-SD-E-01003-Sht 01

APPENDIX G SPECIFICATION DRAWINGS

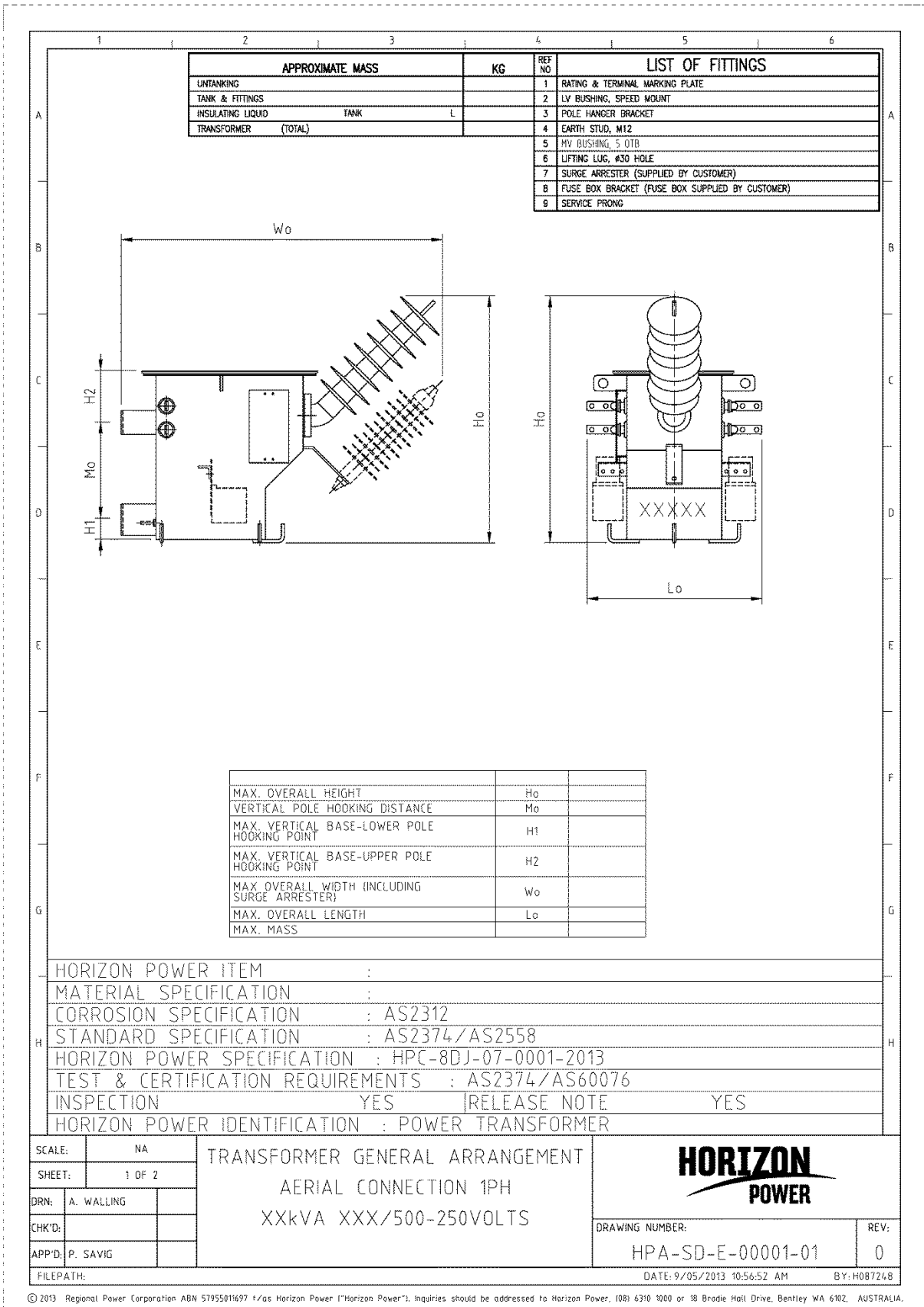

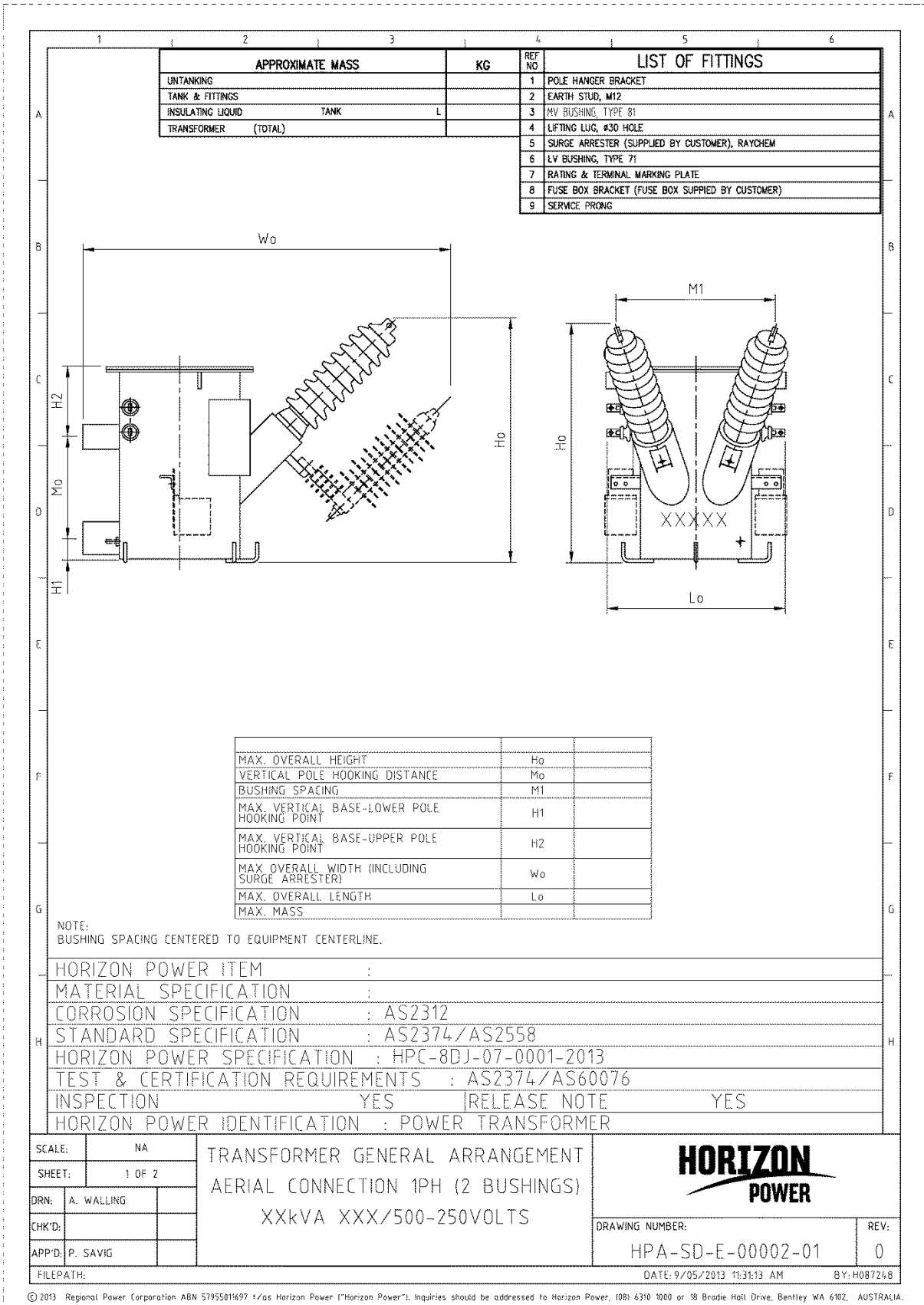

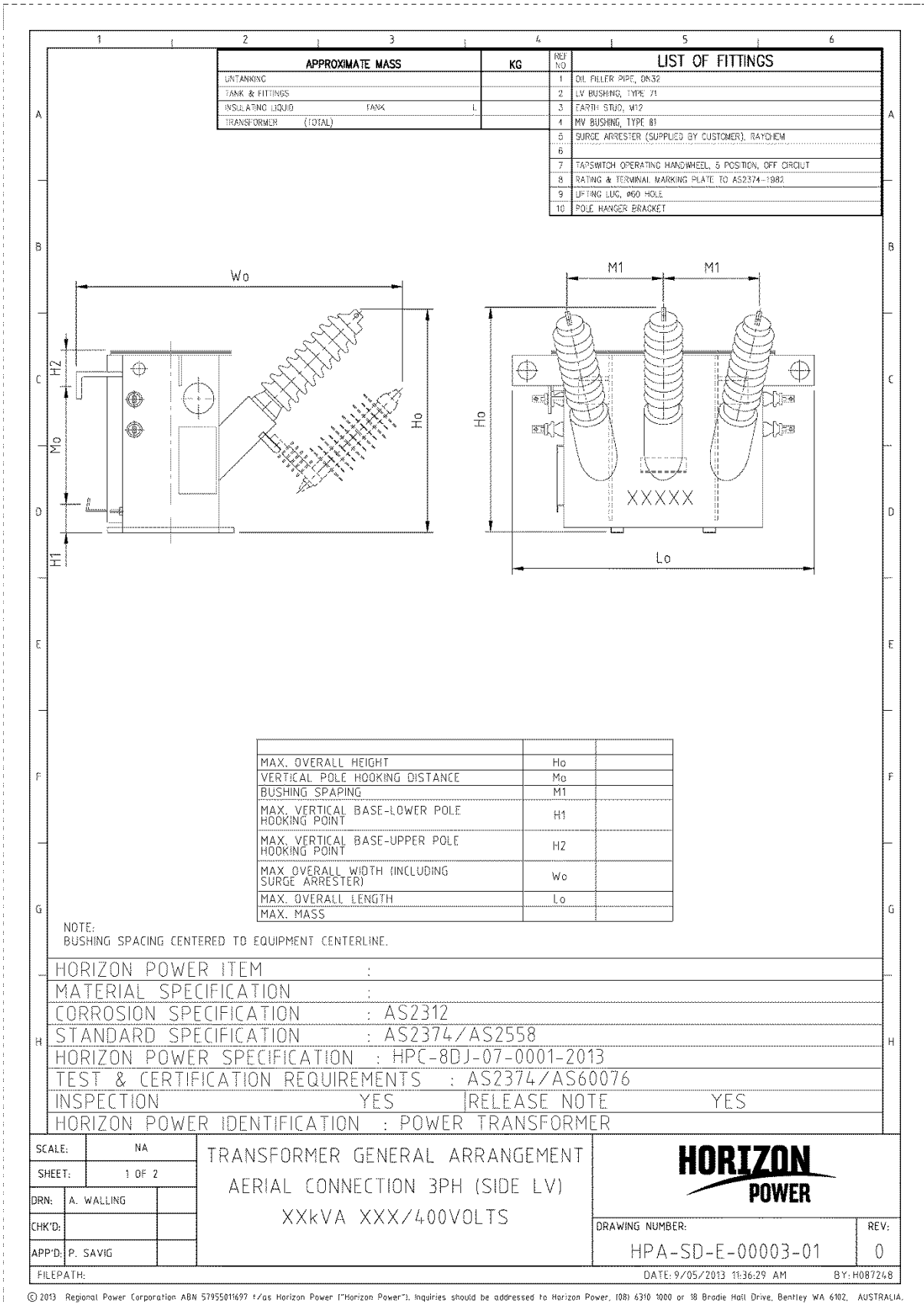

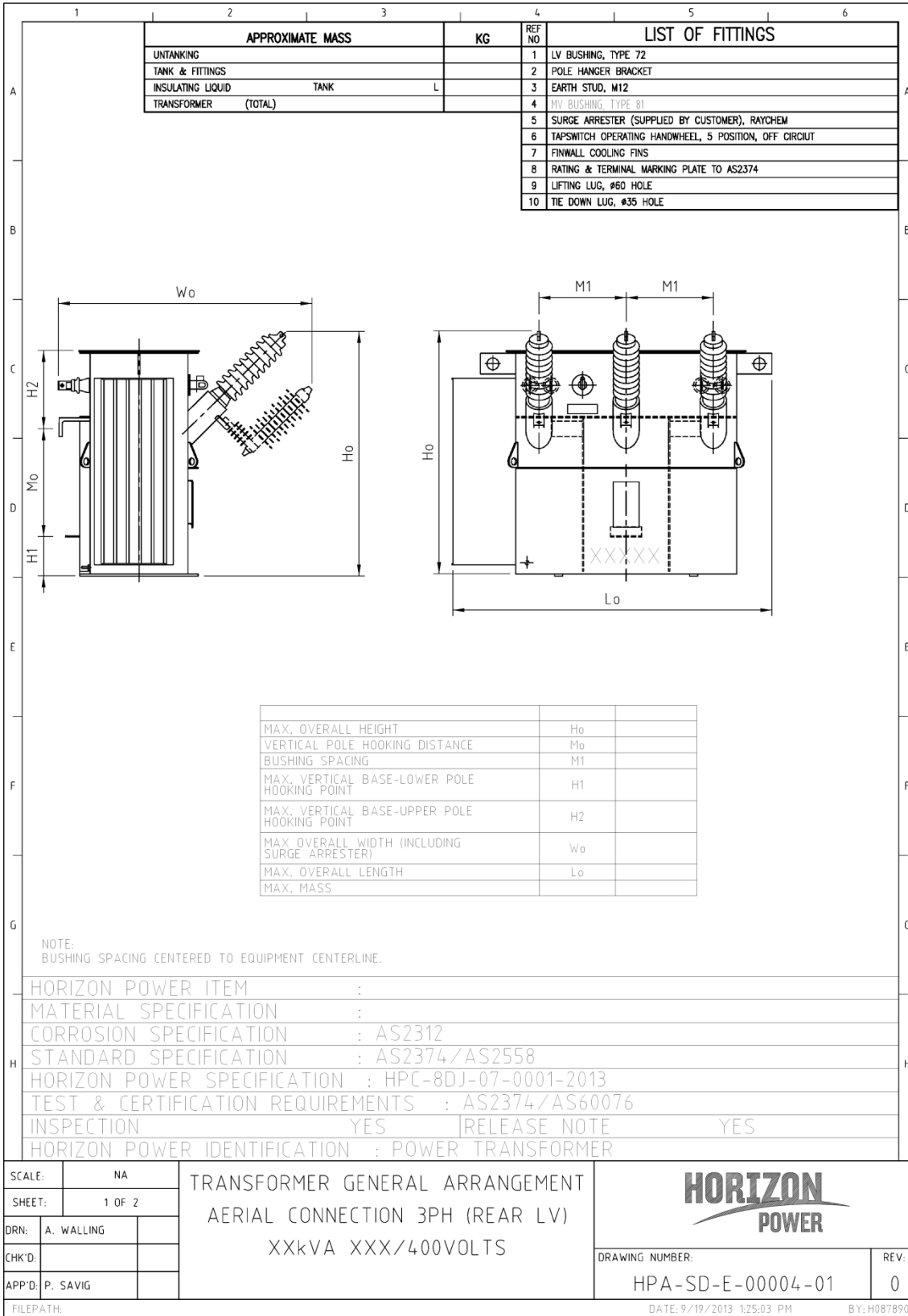

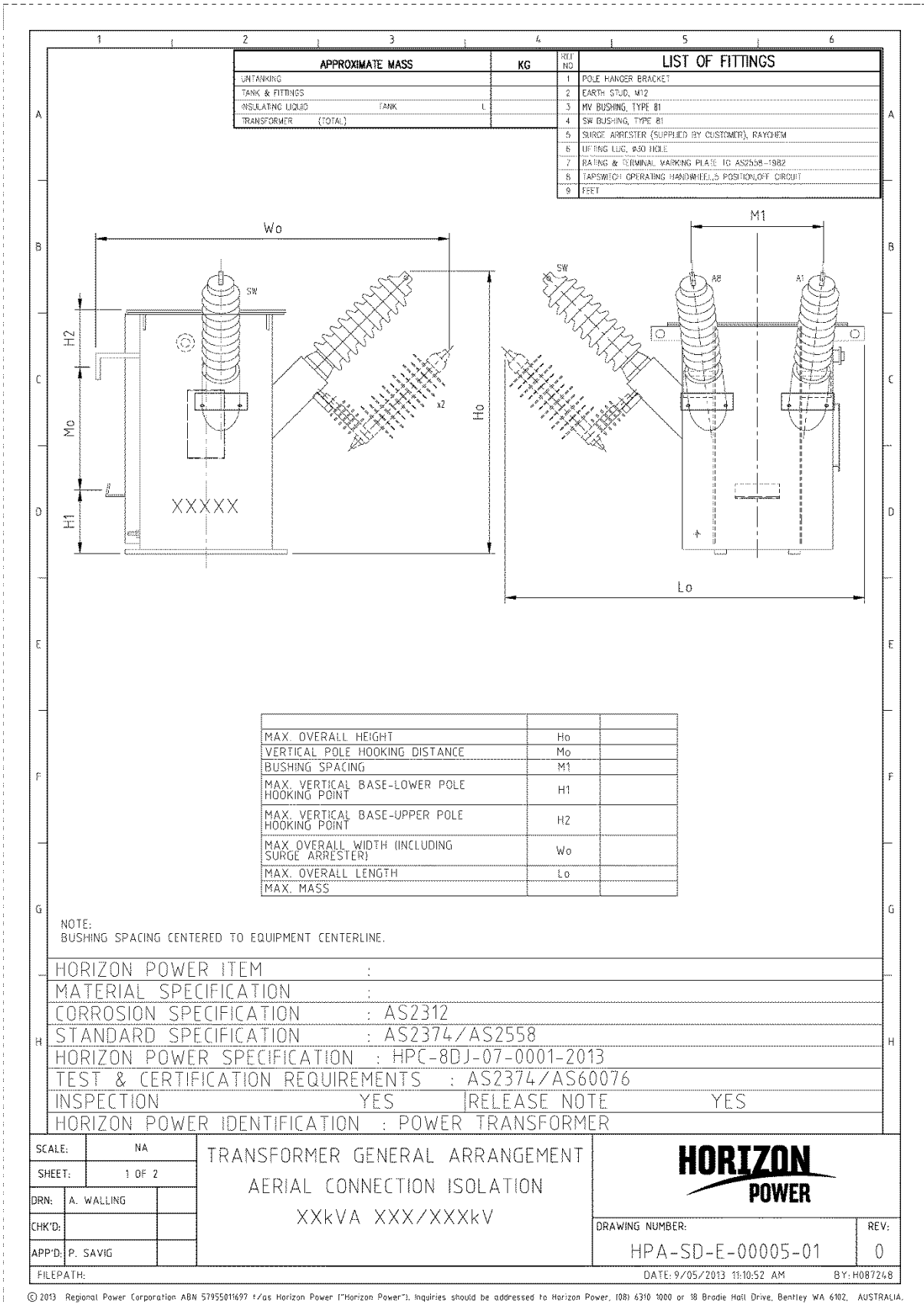

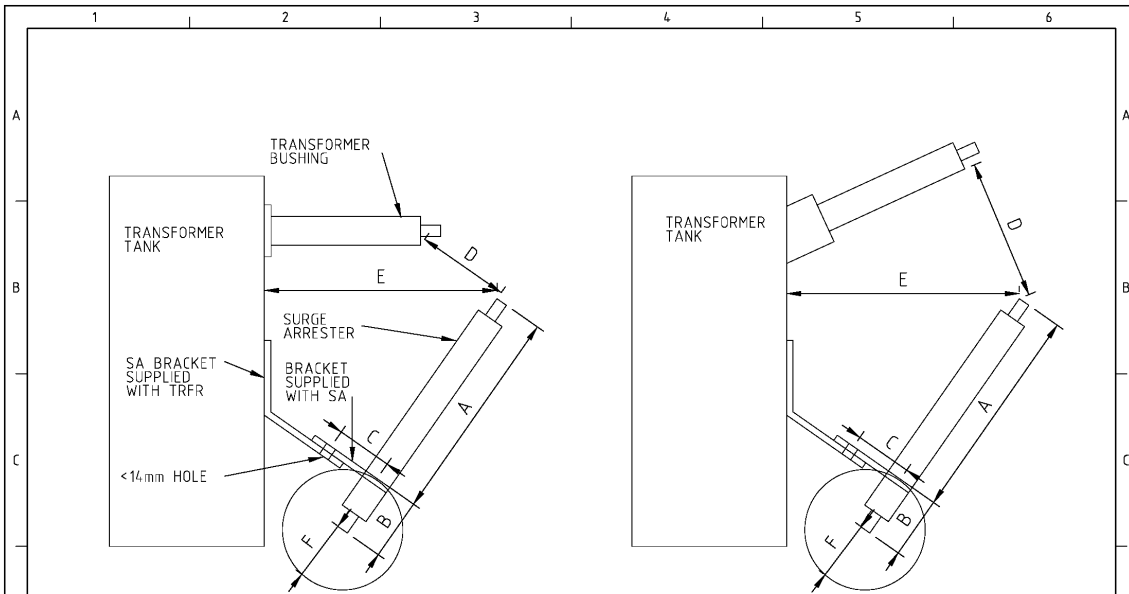

	11kV	22kV	33kV
A	120-250mm	240-400mm	360-450mm
B (MAX)	100mm	100mm	100mm
C (MAX)	130mm	130mm	130mm
D (MAX)	200mm	200mm	200mm
E (MAX)	190mm	300mm	400mm
F (MAX)	150mm	150mm	150mm

NOTE:

1. D - SHORTEST DISTANCE BETWEEN SA LINE TERMINAL AND TRANSFORMER BUSHING.
2. E - SHORTEST DISTANCE BETWEEN SA LINE TERMINAL AND ANY EARTHED METAL.
3. F - RADIUS SHALL BE CLEAR OF ANY OBJECTIONS.
4. PARAMETERS A, B AND C ARE GIVEN VALUES SPECIFIED BY THE SA MANUFACTURES.
5. TRANSFORMERS SHALL BE DESIGNED TO COMPLY WITH PARAMETERS D, E AND F.

HORIZON POWER ITEM	:	
MATERIAL SPECIFICATION	:	
CORROSION SPECIFICATION	:	
STANDARD SPECIFICATION	:	
HORIZON POWER SPECIFICATION	:	
TEST & CERTIFICATION REQUIREMENTS	:	
INSPECTION	YES	RELEASE NOTE YES
HORIZON POWER IDENTIFICATION : POWER TRANSFORMER		

SCALE:	1:25	TRANSFORMER GENERAL ARRANGEMENT AERIAL CONNECTION SURGE ARRESTER APPLICATION			
SHEET:	1 OF 2				
DRN:	A. WALLING				
CHK'D:					
APP'D:	P. SAVIG				
FILEPATH:		DRAWING NUMBER:	HPA-SD-E-00006-01	REV:	0
		DATE: 9/05/2013 11:11:51 AM		BY: H087248	

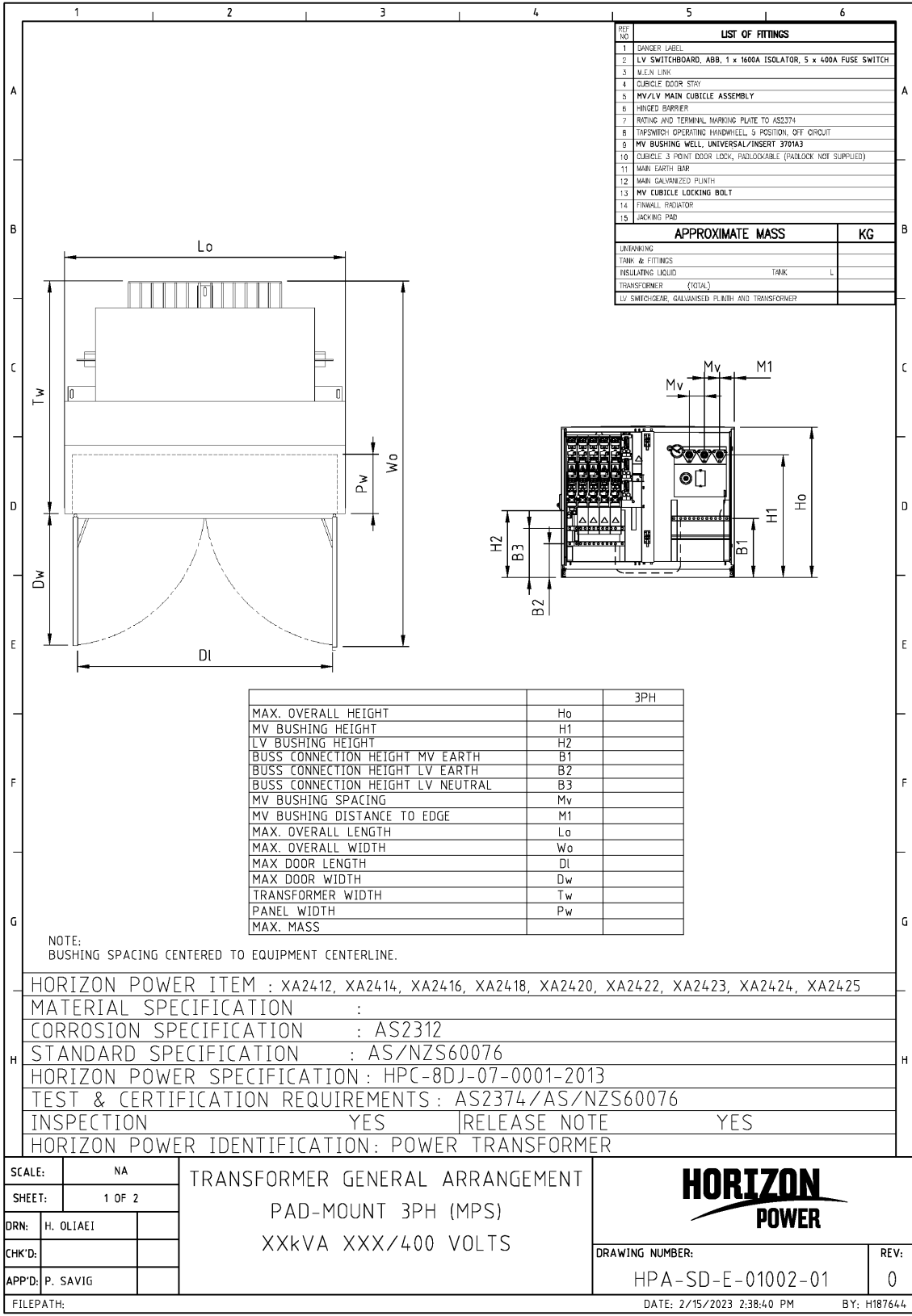

© 2013 Regional Power Corporation ABN 57955011697 t/as Horizon Power ("Horizon Power"). Inquiries should be addressed to Horizon Power, (08) 6310 1000 or 18 Brodie Hall Drive, Bentley WA 6102, AUSTRALIA.

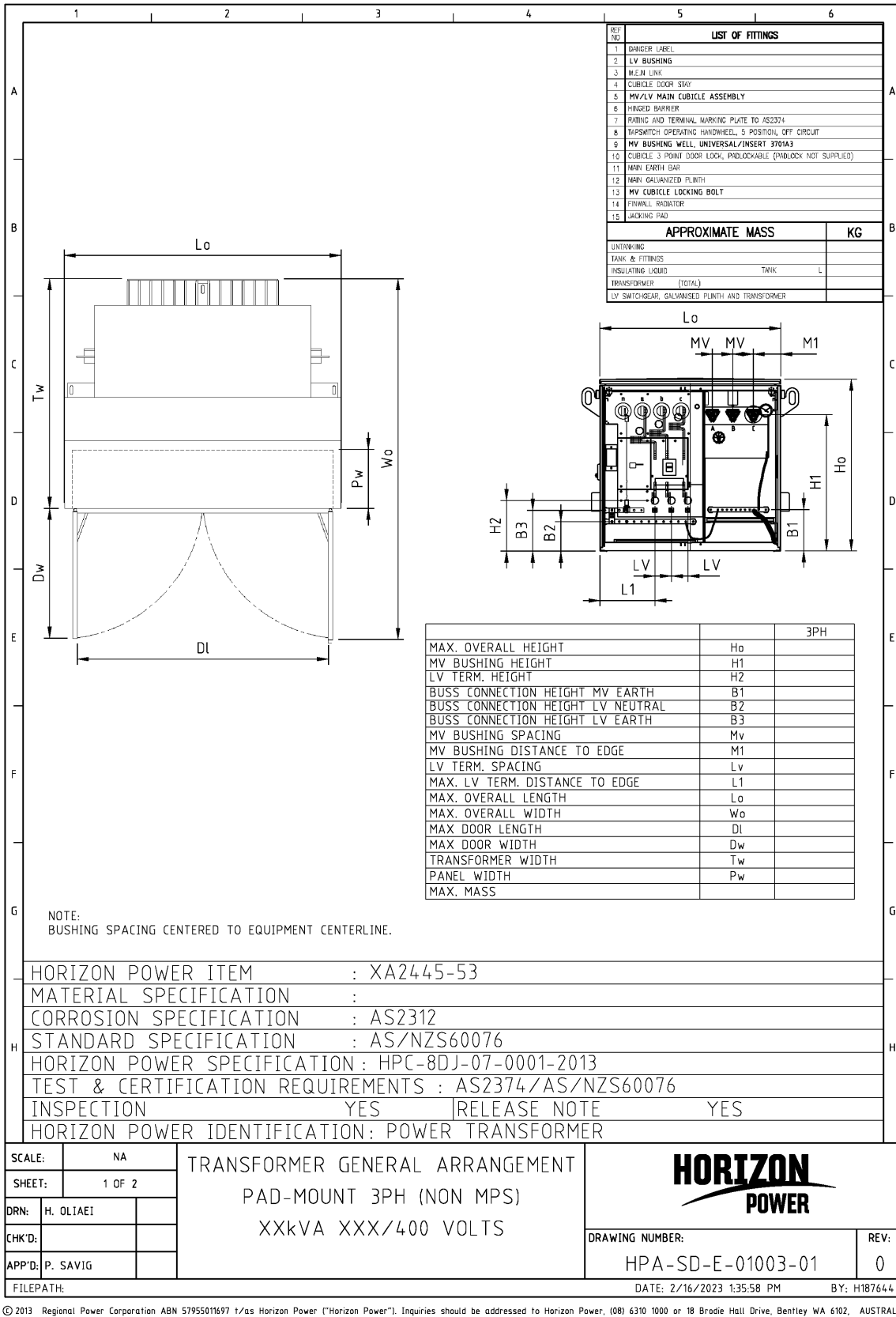

© 2013 Regional Power Corporation ABN 57955011697 t/as Horizon Power ("Horizon Power"). Inquiries should be addressed to Horizon Power, (08) 6310 1000 or 18 Bradie Hall Drive, Bentley WA 6102, AUSTRALIA.

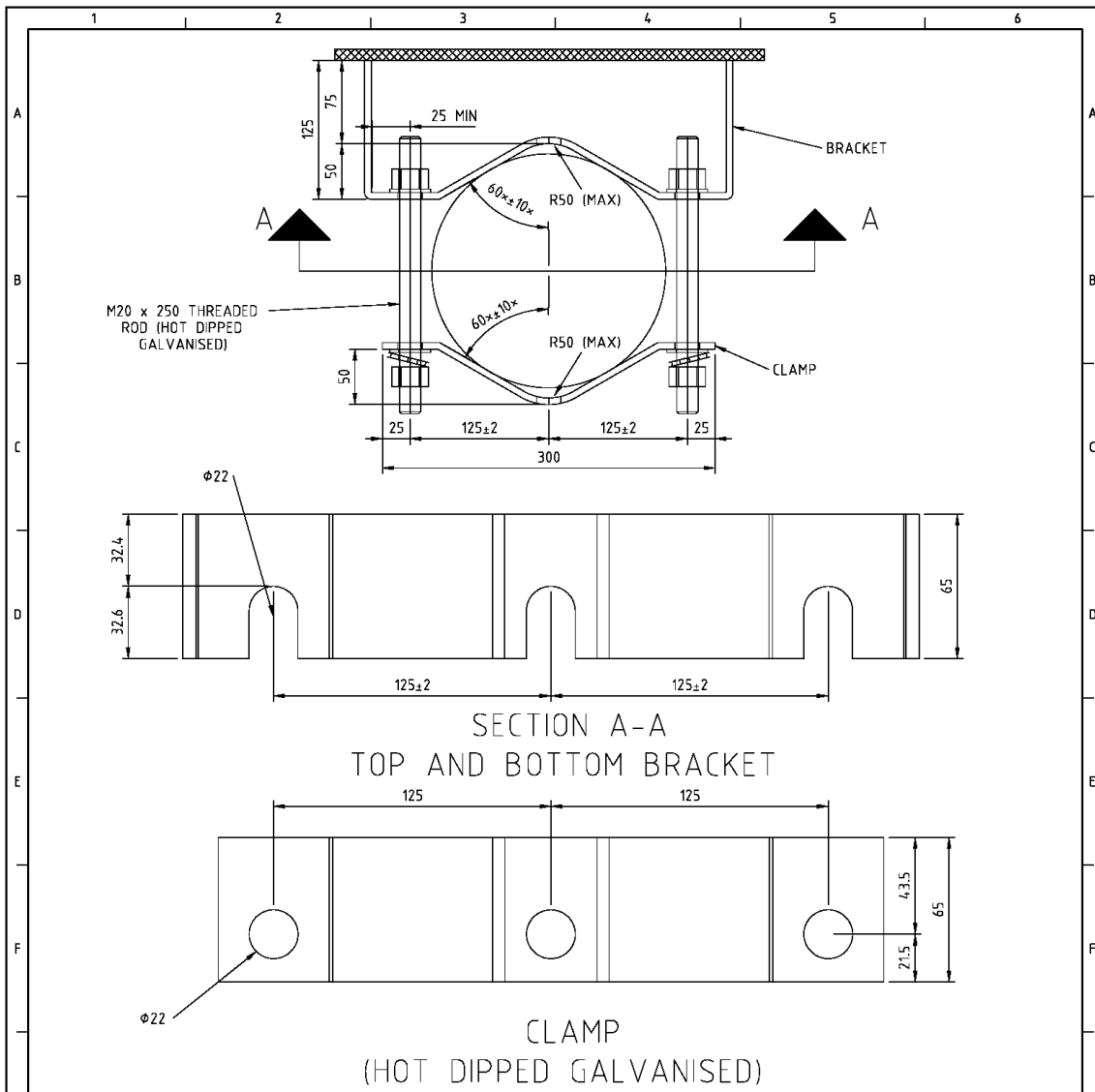

NOTE:
DIMENSIONS ARE SUBJECT TO A TOLERANCE OF ±1mm UNLESS OTHERWISE STATED.

HORIZON POWER ITEM	:	
MATERIAL SPECIFICATION	:	
CORROSION SPECIFICATION	:	AS2312
STANDARD SPECIFICATION	:	
HORIZON POWER SPECIFICATION	:	
TEST & CERTIFICATION REQUIREMENTS	:	
INSPECTION	YES	RELEASE NOTE YES
HORIZON POWER IDENTIFICATION : BRACKET, MOUNTING POLE		

SCALE:	1:25	BRACKET & CLAMP ARRANGEMENT AERIAL MOUNTING	HORIZON POWER
SHEET:	1 OF 2		
DRN:	A. WALLING		
CHK'D:			
APP'D:	P. SAVIG		
FILEPATH:		DRAWING NUMBER:	HPA-SD-S-00001-01
		DATE:	9/05/2013 11:20:27 AM
		BY:	H087248
		REV:	0

© 2013 Regional Power Corporation ABN 57955011697 1/us Horizon Power ("Horizon Power"). Inquiries should be addressed to Horizon Power, 108 6310 1000 or 18 Brodie Hall Drive, Bentley WA 6102, AUSTRALIA.

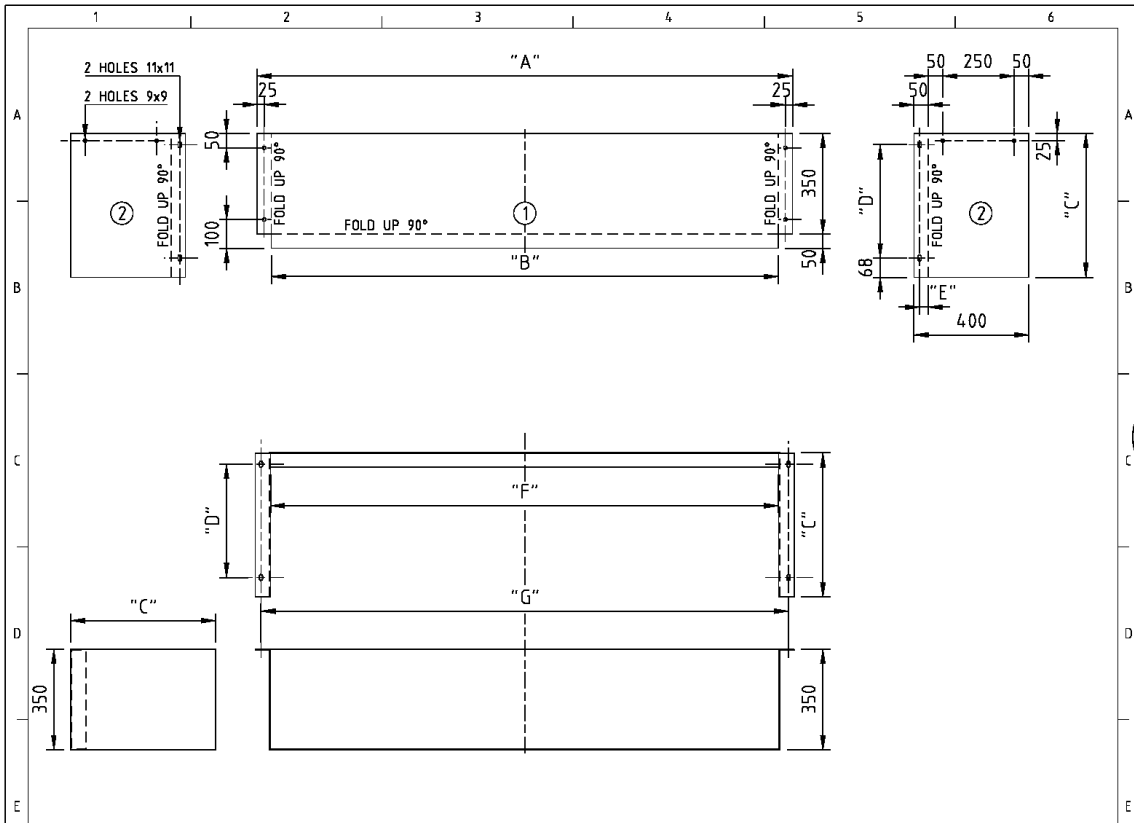

- ① 3 THK GALVANISED
- ② 3 THK GALVANISED

NOTES:

1. REMOVE ALL BURRS AND SHARP EDGES.
2. STEELWORK TO BE BLAST CLEANED TO CLASS 2.5 IN ACCORDANCE WITH AS 1627 PT.4 PRIOR TO GALVANISING.
3. STEELWORK TO BE HOT DIP GALVANISED TO AS 4680 AFTER FABRICATION.
4. ALL DIMENSIONS IN mm.
5. GALVANISED M10 HARDWARE IS TO BE USED.

ITEM LIST		
DIM.	33kV GUARD	22kV GUARD
"A"	1868mm	1574mm
"B"	1768mm	1474mm
"C"	502mm	448mm
"D"	395mm	340mm
"E"	30mm	33mm
"F"	1774mm	1480mm
"G"	1840mm	1540mm

HORIZON POWER ITEM	: XA-XXXX
MATERIAL SPECIFICATION	: AS1163 GRADE 350
CORROSION SPECIFICATION	: STEELWORK TO BE HOT DIP GALVANISED TO AS 4680
STANDARD SPECIFICATION	: -
HORIZON POWER SPECIFICATION	: HPC-8DJ-07-0001-2013
TEST & CERTIFICATION REQUIREMENTS	: -
INSPECTION	YES
RELEASE NOTE	NO
HORIZON POWER IDENTIFICATION	: NON-MPS, CABLE GUARD

SCALE:	1:20	NON-MPS TRANSFORMER CABLE GUARD	HORIZON POWER
SHEET:	1 OF 1		
DRN:	V. MASTERS	02.06.23	DRAWING NUMBER: HPA-SD-S-0017-01
CHK'D:	P. SAVIG	09.06.23	
APP'D:	P. SAVIG	09.06.23	
FILEPATH:			DATE: 6/9/2023 11:54:12 AM
			BY: H188405

© 2013 Regional Power Corporation ABN 5795501697 t/as Horizon Power ("Horizon Power"). Inquiries should be addressed to Horizon Power, (08) 6310 1000 or 18 Brodie Hall Drive, Bentley WA 6102, AUSTRALIA.